

|                   |                   |                  |
|-------------------|-------------------|------------------|
| Relay<br><b>1</b> | Lane<br><b>12</b> | <b>HAN Kally</b> |
|-------------------|-------------------|------------------|

|                           |    |   |    |
|---------------------------|----|---|----|
| 2023 SFC Pistol Nationals | BC | F | WP |
|---------------------------|----|---|----|

|            |                      |                             |
|------------|----------------------|-----------------------------|
| 16.07.2023 | 2023 PN AP60W Finals | Alberta Handgun Association |
|------------|----------------------|-----------------------------|

|         |           |
|---------|-----------|
| Comment | Signature |
|---------|-----------|

|              |  |                         |  |
|--------------|--|-------------------------|--|
| <p>Sight</p> | <p>1: 9.7 →</p> <p>2: 10.1 ↓</p> <p>3: 8.9 ↓</p> <p>4: 7.8 ↓</p> <p>5: 9.4 →</p> <p>6: 8.8 ↓</p> <p>7: 9.0 ↓</p> | <p>1. Series Finals</p> | <p>1: 10.1 →</p> <p>2: 9.4 ↓</p> <p>3: 9.5 ↑</p> <p>4: 9.2 ↓</p> <p>5: 10.9x ↑</p> |
|              |  |                         |  |

|                         |   |                         |                                 |
|-------------------------|---|-------------------------|---------------------------------|
| <p>2. Series Finals</p> | <p>1: 10.4x ←</p> <p>2: 7.4 ↓</p> <p>3: 8.5 →</p> <p>4: 8.6 ↑</p> <p>5: 8.2 ←</p> | <p>3. Series Finals</p> | <p>1: 9.9 ↑</p> <p>2: 8.5 ↓</p> |
|                         |   |                         |                                 |

|                         |                                 |  |  |
|-------------------------|---------------------------------|--|--|
| <p>4. Series Finals</p> | <p>1: 8.0 ↓</p> <p>2: 8.0 ←</p> |  |  |
|                         |                                 |  |  |

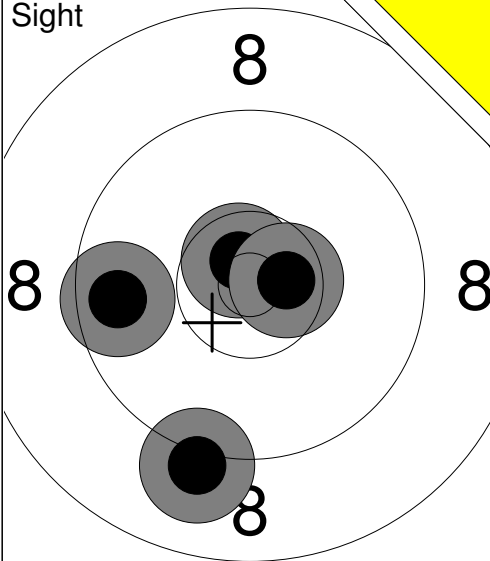
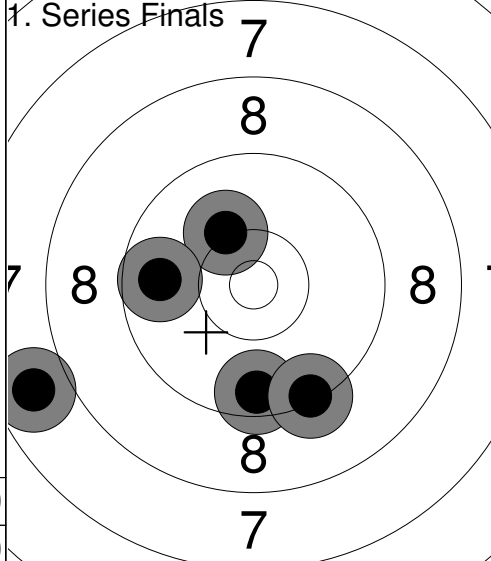
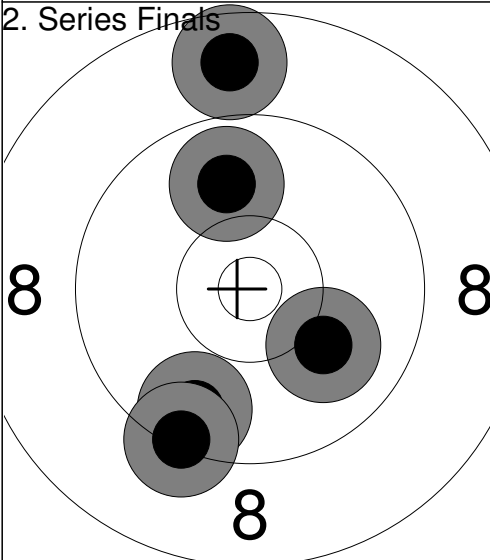
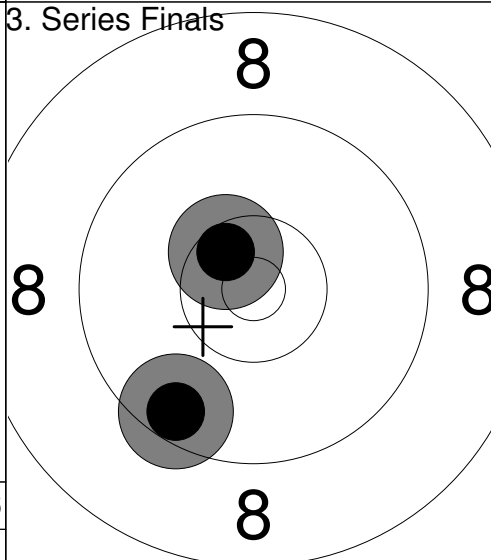
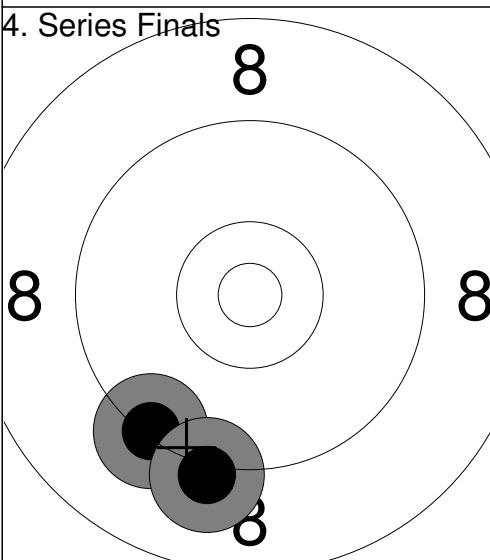
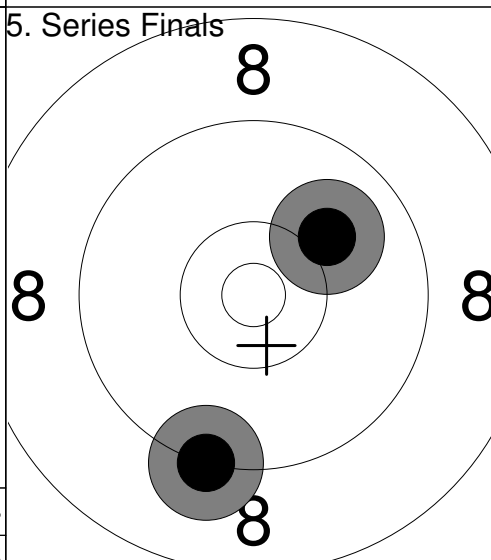
|  |  |  |  |
|--|--|--|--|
| <p>Sight</p>               | <p>1: 9.1 ↓<br/>2: 10.7x ↗<br/>3: 10.6x →<br/>4: 9.6 ←</p> <p>Series 40.0<br/>0.0</p>            | <p>1. Series Finals</p>    | <p>1: 7.8 ←<br/>2: 9.5 ↓<br/>3: 10.2 ↗<br/>4: 9.7 ←<br/>5: 9.3 ↓</p> <p>Series 46.5<br/>46.5</p> |
| <p>2. Series Finals</p>   | <p>1: 9.9 ↑<br/>2: 9.7 ↓<br/>3: 8.7 ↑<br/>4: 9.3 ↓<br/>5: 10.0 ↓</p> <p>Series 47.6<br/>94.1</p> | <p>3. Series Finals</p>   | <p>1: 9.5 ↓<br/>2: 10.5x ↗</p> <p>Series 20.0<br/>114.1</p>                                      |
| <p>4. Series Finals</p>  | <p>1: 9.3 ↓<br/>2: 9.1 ↓</p> <p>Series 18.4<br/>132.5</p>  | <p>5. Series Finals</p>  | <p>1: 10.0 ↗<br/>2: 9.2 ↓</p> <p>Series 19.2<br/>151.7</p>                                       |

|                   |                   |                             |
|-------------------|-------------------|-----------------------------|
| Relay<br><b>1</b> | Lane<br><b>14</b> | <b>LE SIEUR Audrey anne</b> |
|-------------------|-------------------|-----------------------------|

|                           |    |   |    |
|---------------------------|----|---|----|
| 2023 SFC Pistol Nationals | QC | F | WP |
|---------------------------|----|---|----|

|            |                      |                             |
|------------|----------------------|-----------------------------|
| 16.07.2023 | 2023 PN AP60W Finals | Alberta Handgun Association |
|------------|----------------------|-----------------------------|

|         |           |
|---------|-----------|
| Comment | Signature |
|---------|-----------|

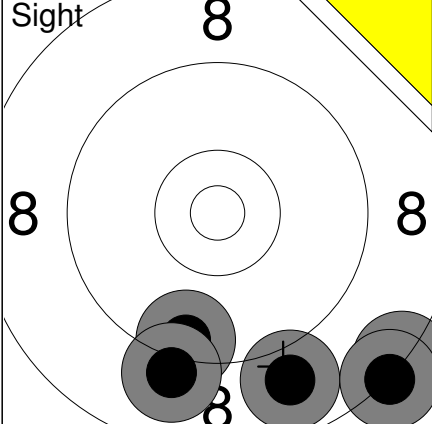
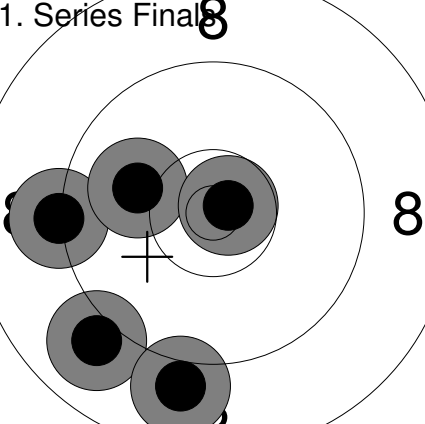
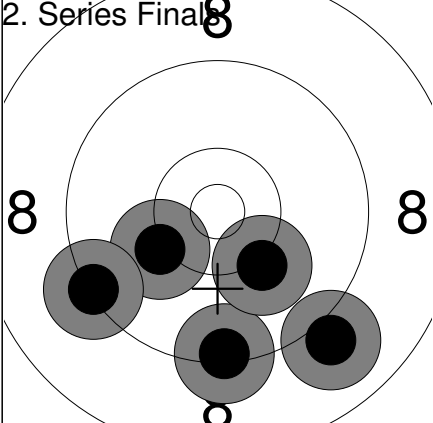
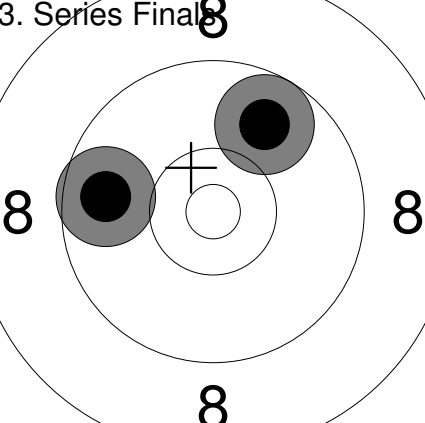
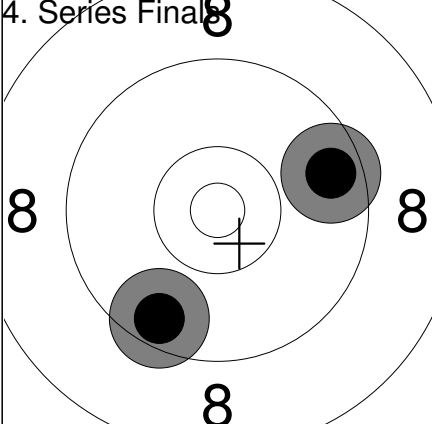
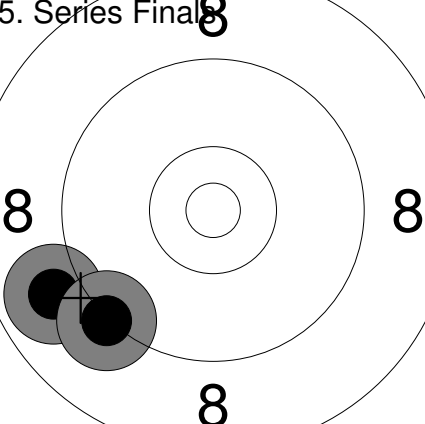
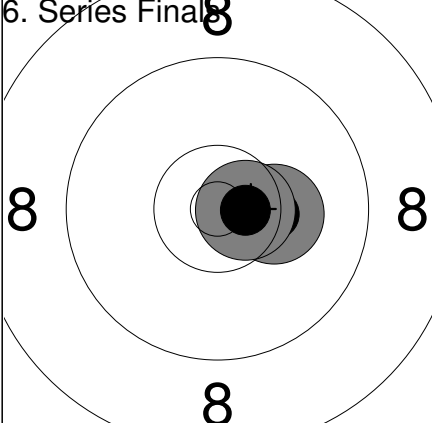
|  |   |  |  |
|--|---|--|--|
| <p>Sight <b>8</b></p>              | <p>1: 8.9 ↓<br/>2: 8.2 ↓<br/>3: 9.5 ↓<br/>4: 9.1 ↓<br/>5: 8.2 ↓</p>   | <p>1. Series Final <b>8</b></p>    | <p>1: 9.2 ←<br/>2: 10.0 ←<br/>3: 10.8x →<br/>4: 9.0 ↓<br/>5: 8.9 ↓</p> |
| <p style="text-align: right;">Series 43.9</p> <p style="text-align: right;">0.0</p>                                |   | <p style="text-align: right;">Series 47.9</p> <p style="text-align: right;">47.9</p>                                 |  |
| <p>2. Series Final <b>8</b></p>   | <p>1: 10.2 ←<br/>2: 9.3 ↓<br/>3: 9.0 ↓<br/>4: 9.3 ←<br/>5: 10.2 ↓</p> | <p>3. Series Final <b>8</b></p>   | <p>1: 9.7 ←<br/>2: 9.8 ↗</p>   |
| <p style="text-align: right;">Series 48.0</p> <p style="text-align: right;">95.9</p>                               |   | <p style="text-align: right;">Series 19.5</p> <p style="text-align: right;">115.4</p>                                |  |
| <p>4. Series Final <b>8</b></p>  | <p>1: 9.6 →<br/>2: 9.6 ↓</p>  | <p>5. Series Final <b>8</b></p>  | <p>1: 8.9 ←<br/>2: 9.2 ↓</p>   |
| <p style="text-align: right;">Series 19.2</p> <p style="text-align: right;">134.6</p>                              |   | <p style="text-align: right;">Series 18.1</p> <p style="text-align: right;">152.7</p>                                |  |
| <p>6. Series Final <b>8</b></p>  | <p>1: 10.3 →<br/>2: 10.6x →</p>                                       |  |  |
| <p style="text-align: right;">Series 20.9</p> <p style="text-align: right;">173.6</p>                              |   |  |  |

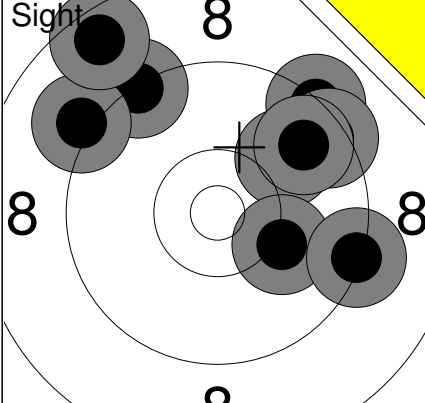
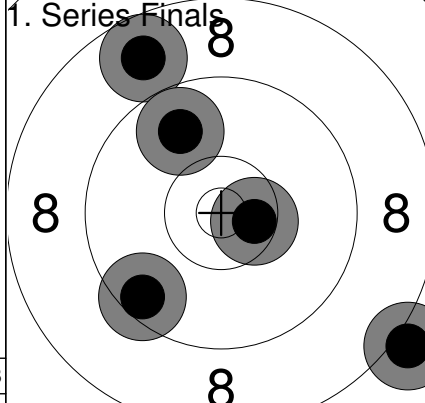
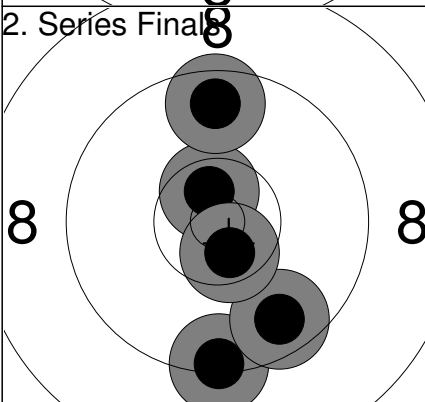
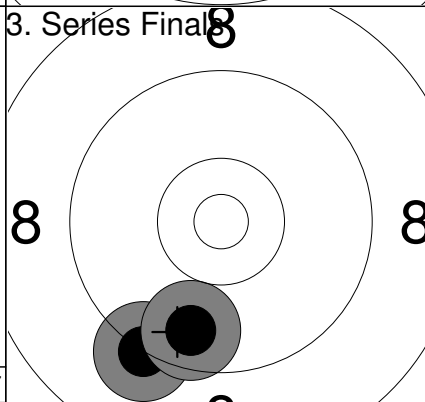
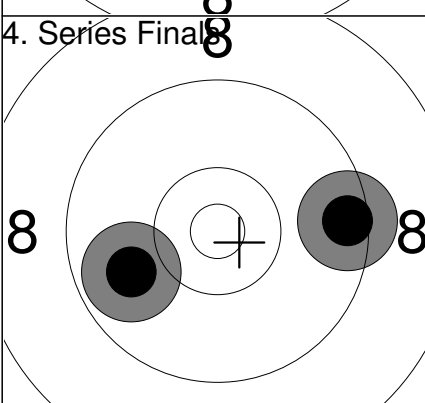
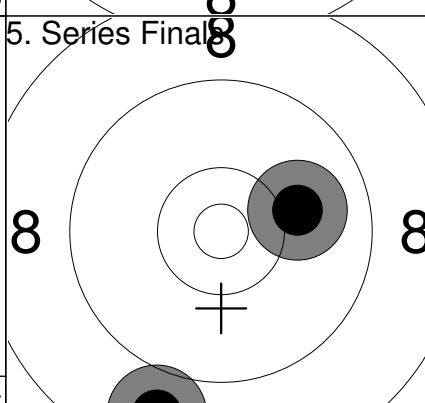
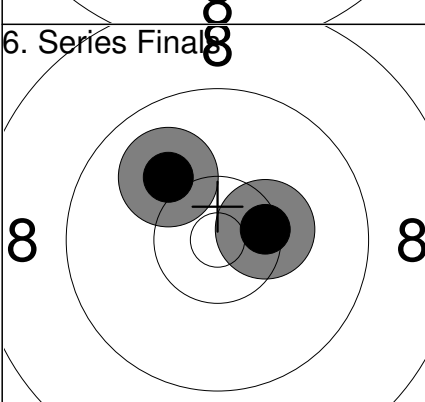
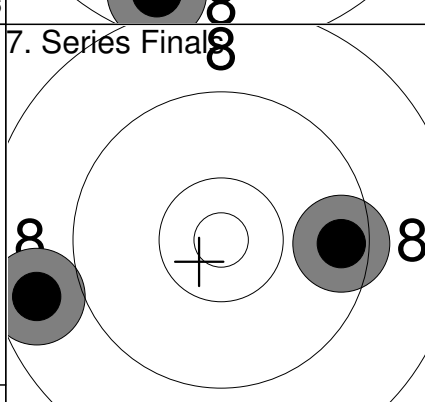
|  |  |       |       |   |    |       |   |        |      |      |    |     |       |   |       |      |        |     |      |    |        |      |   |     |     |       |     |     |        |        |      |      |  |     |  |    |     |   |    |     |   |    |     |   |    |     |   |    |       |   |        |  |      |  |  |      |
|--|--|-------|-------|---|----|-------|---|--------|------|------|----|-----|-------|---|-------|------|--------|-----|------|----|--------|------|---|-----|-----|-------|-----|-----|--------|--------|------|------|--|-----|--|----|-----|---|----|-----|---|----|-----|---|----|-----|---|----|-------|---|--------|--|------|--|--|------|
|  <p>Sight</p>              | <table border="1" style="width:100%; border-collapse: collapse;"> <tr><td>1:</td><td>10.0</td><td>↗</td></tr> <tr><td>2:</td><td>9.3</td><td>↗</td></tr> <tr><td>3:</td><td>10.1</td><td>↘</td></tr> <tr><td>4:</td><td>9.3</td><td>↗</td></tr> <tr><td>5:</td><td>9.4</td><td>↗</td></tr> <tr><td>6:</td><td>9.7</td><td>↗</td></tr> <tr><td>7:</td><td>9.1</td><td>↗</td></tr> <tr><td>8:</td><td>8.6</td><td>↗</td></tr> <tr><td>9:</td><td>9.3</td><td>↘</td></tr> <tr><td colspan="2">Series</td><td>84.8</td></tr> <tr><td colspan="2"></td><td>0.0</td></tr> </table> | 1:    | 10.0  | ↗ | 2: | 9.3   | ↗ | 3:     | 10.1 | ↘    | 4: | 9.3 | ↗     | 5:  | 9.4   | ↗    | 6:     | 9.7 | ↗    | 7: | 9.1    | ↗    | 8:  | 8.6 | ↗   | 9:    | 9.3 | ↘   | Series |        | 84.8 |      |  | 0.0 |  <p>1. Series Finals</p> <table border="1" style="width:100%; border-collapse: collapse;"> <tr><td>1:</td><td>8.8</td><td>↗</td></tr> <tr><td>2:</td><td>9.8</td><td>↗</td></tr> <tr><td>3:</td><td>9.5</td><td>↘</td></tr> <tr><td>4:</td><td>8.0</td><td>↘</td></tr> <tr><td>5:</td><td>10.5x</td><td>→</td></tr> <tr><td colspan="2">Series</td><td>46.6</td></tr> <tr><td colspan="2"></td><td>46.6</td></tr> </table> | 1: | 8.8 | ↗ | 2: | 9.8 | ↗ | 3: | 9.5 | ↘ | 4: | 8.0 | ↘ | 5: | 10.5x | → | Series |  | 46.6 |  |  | 46.6 |
| 1:   | 10.0   | ↗     |       |   |    |       |   |        |      |      |    |     |       |   |       |      |        |     |      |    |        |      |   |     |     |       |     |     |        |        |      |      |  |     |  |    |     |   |    |     |   |    |     |   |    |     |   |    |       |   |        |  |      |  |  |      |
| 2:   | 9.3  | ↗     |       |   |    |       |   |        |      |      |    |     |       |   |       |      |        |     |      |    |        |      |   |     |     |       |     |     |        |        |      |      |  |     |  |    |     |   |    |     |   |    |     |   |    |     |   |    |       |   |        |  |      |  |  |      |
| 3:   | 10.1   | ↘     |       |   |    |       |   |        |      |      |    |     |       |   |       |      |        |     |      |    |        |      |   |     |     |       |     |     |        |        |      |      |  |     |  |    |     |   |    |     |   |    |     |   |    |     |   |    |       |   |        |  |      |  |  |      |
| 4:   | 9.3  | ↗     |       |   |    |       |   |        |      |      |    |     |       |   |       |      |        |     |      |    |        |      |   |     |     |       |     |     |        |        |      |      |  |     |  |    |     |   |    |     |   |    |     |   |    |     |   |    |       |   |        |  |      |  |  |      |
| 5:   | 9.4  | ↗     |       |   |    |       |   |        |      |      |    |     |       |   |       |      |        |     |      |    |        |      |   |     |     |       |     |     |        |        |      |      |  |     |  |    |     |   |    |     |   |    |     |   |    |     |   |    |       |   |        |  |      |  |  |      |
| 6:   | 9.7  | ↗     |       |   |    |       |   |        |      |      |    |     |       |   |       |      |        |     |      |    |        |      |   |     |     |       |     |     |        |        |      |      |  |     |  |    |     |   |    |     |   |    |     |   |    |     |   |    |       |   |        |  |      |  |  |      |
| 7:   | 9.1  | ↗     |       |   |    |       |   |        |      |      |    |     |       |   |       |      |        |     |      |    |        |      |   |     |     |       |     |     |        |        |      |      |  |     |  |    |     |   |    |     |   |    |     |   |    |     |   |    |       |   |        |  |      |  |  |      |
| 8:   | 8.6  | ↗     |       |   |    |       |   |        |      |      |    |     |       |   |       |      |        |     |      |    |        |      |   |     |     |       |     |     |        |        |      |      |  |     |  |    |     |   |    |     |   |    |     |   |    |     |   |    |       |   |        |  |      |  |  |      |
| 9:   | 9.3  | ↘     |       |   |    |       |   |        |      |      |    |     |       |   |       |      |        |     |      |    |        |      |   |     |     |       |     |     |        |        |      |      |  |     |  |    |     |   |    |     |   |    |     |   |    |     |   |    |       |   |        |  |      |  |  |      |
| Series   |  | 84.8  |       |   |    |       |   |        |      |      |    |     |       |   |       |      |        |     |      |    |        |      |   |     |     |       |     |     |        |        |      |      |  |     |  |    |     |   |    |     |   |    |     |   |    |     |   |    |       |   |        |  |      |  |  |      |
|  |  | 0.0   |       |   |    |       |   |        |      |      |    |     |       |   |       |      |        |     |      |    |        |      |   |     |     |       |     |     |        |        |      |      |  |     |  |    |     |   |    |     |   |    |     |   |    |     |   |    |       |   |        |  |      |  |  |      |
| 1:   | 8.8  | ↗     |       |   |    |       |   |        |      |      |    |     |       |   |       |      |        |     |      |    |        |      |   |     |     |       |     |     |        |        |      |      |  |     |  |    |     |   |    |     |   |    |     |   |    |     |   |    |       |   |        |  |      |  |  |      |
| 2:   | 9.8  | ↗     |       |   |    |       |   |        |      |      |    |     |       |   |       |      |        |     |      |    |        |      |   |     |     |       |     |     |        |        |      |      |  |     |  |    |     |   |    |     |   |    |     |   |    |     |   |    |       |   |        |  |      |  |  |      |
| 3:   | 9.5  | ↘     |       |   |    |       |   |        |      |      |    |     |       |   |       |      |        |     |      |    |        |      |   |     |     |       |     |     |        |        |      |      |  |     |  |    |     |   |    |     |   |    |     |   |    |     |   |    |       |   |        |  |      |  |  |      |
| 4:   | 8.0  | ↘     |       |   |    |       |   |        |      |      |    |     |       |   |       |      |        |     |      |    |        |      |   |     |     |       |     |     |        |        |      |      |  |     |  |    |     |   |    |     |   |    |     |   |    |     |   |    |       |   |        |  |      |  |  |      |
| 5:   | 10.5x  | →     |       |   |    |       |   |        |      |      |    |     |       |   |       |      |        |     |      |    |        |      |   |     |     |       |     |     |        |        |      |      |  |     |  |    |     |   |    |     |   |    |     |   |    |     |   |    |       |   |        |  |      |  |  |      |
| Series   |  | 46.6  |       |   |    |       |   |        |      |      |    |     |       |   |       |      |        |     |      |    |        |      |   |     |     |       |     |     |        |        |      |      |  |     |  |    |     |   |    |     |   |    |     |   |    |     |   |    |       |   |        |  |      |  |  |      |
|  |  | 46.6  |       |   |    |       |   |        |      |      |    |     |       |   |       |      |        |     |      |    |        |      |   |     |     |       |     |     |        |        |      |      |  |     |  |    |     |   |    |     |   |    |     |   |    |     |   |    |       |   |        |  |      |  |  |      |
|  <p>2. Series Finals</p>  | <table border="1" style="width:100%; border-collapse: collapse;"> <tr><td>1:</td><td>9.3</td><td>↓</td></tr> <tr><td>2:</td><td>10.6x</td><td>↗</td></tr> <tr><td>3:</td><td>9.6</td><td>↗</td></tr> <tr><td>4:</td><td>9.6</td><td>↘</td></tr> <tr><td>5:</td><td>10.6x</td><td>↘</td></tr> <tr><td colspan="2">Series</td><td>49.7</td></tr> <tr><td colspan="2"></td><td>96.3</td></tr> </table>  | 1:    | 9.3   | ↓ | 2: | 10.6x | ↗ | 3:     | 9.6  | ↗    | 4: | 9.6 | ↘     | 5:  | 10.6x | ↘    | Series |     | 49.7 |    |        | 96.3 |  <p>3. Series Finals</p> <table border="1" style="width:100%; border-collapse: collapse;"> <tr><td>1:</td><td>9.2</td><td>↘</td></tr> <tr><td>2:</td><td>9.7</td><td>↘</td></tr> <tr><td colspan="2">Series</td><td>18.9</td></tr> <tr><td colspan="2"></td><td>115.2</td></tr> </table> | 1:  | 9.2 | ↘     | 2:  | 9.7 | ↘      | Series |      | 18.9 |  |     | 115.2  |    |     |   |    |     |   |    |     |   |    |     |   |    |       |   |        |  |      |  |  |      |
| 1:   | 9.3  | ↓     |       |   |    |       |   |        |      |      |    |     |       |   |       |      |        |     |      |    |        |      |   |     |     |       |     |     |        |        |      |      |  |     |  |    |     |   |    |     |   |    |     |   |    |     |   |    |       |   |        |  |      |  |  |      |
| 2:   | 10.6x  | ↗     |       |   |    |       |   |        |      |      |    |     |       |   |       |      |        |     |      |    |        |      |   |     |     |       |     |     |        |        |      |      |  |     |  |    |     |   |    |     |   |    |     |   |    |     |   |    |       |   |        |  |      |  |  |      |
| 3:   | 9.6  | ↗     |       |   |    |       |   |        |      |      |    |     |       |   |       |      |        |     |      |    |        |      |   |     |     |       |     |     |        |        |      |      |  |     |  |    |     |   |    |     |   |    |     |   |    |     |   |    |       |   |        |  |      |  |  |      |
| 4:   | 9.6  | ↘     |       |   |    |       |   |        |      |      |    |     |       |   |       |      |        |     |      |    |        |      |   |     |     |       |     |     |        |        |      |      |  |     |  |    |     |   |    |     |   |    |     |   |    |     |   |    |       |   |        |  |      |  |  |      |
| 5:   | 10.6x  | ↘     |       |   |    |       |   |        |      |      |    |     |       |   |       |      |        |     |      |    |        |      |   |     |     |       |     |     |        |        |      |      |  |     |  |    |     |   |    |     |   |    |     |   |    |     |   |    |       |   |        |  |      |  |  |      |
| Series   |  | 49.7  |       |   |    |       |   |        |      |      |    |     |       |   |       |      |        |     |      |    |        |      |   |     |     |       |     |     |        |        |      |      |  |     |  |    |     |   |    |     |   |    |     |   |    |     |   |    |       |   |        |  |      |  |  |      |
|  |  | 96.3  |       |   |    |       |   |        |      |      |    |     |       |   |       |      |        |     |      |    |        |      |   |     |     |       |     |     |        |        |      |      |  |     |  |    |     |   |    |     |   |    |     |   |    |     |   |    |       |   |        |  |      |  |  |      |
| 1:   | 9.2  | ↘     |       |   |    |       |   |        |      |      |    |     |       |   |       |      |        |     |      |    |        |      |   |     |     |       |     |     |        |        |      |      |  |     |  |    |     |   |    |     |   |    |     |   |    |     |   |    |       |   |        |  |      |  |  |      |
| 2:   | 9.7  | ↘     |       |   |    |       |   |        |      |      |    |     |       |   |       |      |        |     |      |    |        |      |   |     |     |       |     |     |        |        |      |      |  |     |  |    |     |   |    |     |   |    |     |   |    |     |   |    |       |   |        |  |      |  |  |      |
| Series   |  | 18.9  |       |   |    |       |   |        |      |      |    |     |       |   |       |      |        |     |      |    |        |      |   |     |     |       |     |     |        |        |      |      |  |     |  |    |     |   |    |     |   |    |     |   |    |     |   |    |       |   |        |  |      |  |  |      |
|  |  | 115.2 |       |   |    |       |   |        |      |      |    |     |       |   |       |      |        |     |      |    |        |      |   |     |     |       |     |     |        |        |      |      |  |     |  |    |     |   |    |     |   |    |     |   |    |     |   |    |       |   |        |  |      |  |  |      |
|  <p>4. Series Finals</p> | <table border="1" style="width:100%; border-collapse: collapse;"> <tr><td>1:</td><td>9.9</td><td>←</td></tr> <tr><td>2:</td><td>9.5</td><td>→</td></tr> <tr><td colspan="2">Series</td><td>19.4</td></tr> <tr><td colspan="2"></td><td>134.6</td></tr> </table>  | 1:    | 9.9   | ← | 2: | 9.5   | → | Series |      | 19.4 |    |     | 134.6 |  <p>5. Series Finals</p> <table border="1" style="width:100%; border-collapse: collapse;"> <tr><td>1:</td><td>10.0</td><td>→</td></tr> <tr><td>2:</td><td>8.7</td><td>↘</td></tr> <tr><td colspan="2">Series</td><td>18.7</td></tr> <tr><td colspan="2"></td><td>153.3</td></tr> </table> | 1:    | 10.0 | →      | 2:  | 8.7  | ↘  | Series |      | 18.7  |     |     | 153.3 |     |     |        |        |      |      |  |     |  |    |     |   |    |     |   |    |     |   |    |     |   |    |       |   |        |  |      |  |  |      |
| 1:   | 9.9  | ←     |       |   |    |       |   |        |      |      |    |     |       |   |       |      |        |     |      |    |        |      |   |     |     |       |     |     |        |        |      |      |  |     |  |    |     |   |    |     |   |    |     |   |    |     |   |    |       |   |        |  |      |  |  |      |
| 2:   | 9.5  | →     |       |   |    |       |   |        |      |      |    |     |       |   |       |      |        |     |      |    |        |      |   |     |     |       |     |     |        |        |      |      |  |     |  |    |     |   |    |     |   |    |     |   |    |     |   |    |       |   |        |  |      |  |  |      |
| Series   |  | 19.4  |       |   |    |       |   |        |      |      |    |     |       |   |       |      |        |     |      |    |        |      |   |     |     |       |     |     |        |        |      |      |  |     |  |    |     |   |    |     |   |    |     |   |    |     |   |    |       |   |        |  |      |  |  |      |
|  |  | 134.6 |       |   |    |       |   |        |      |      |    |     |       |   |       |      |        |     |      |    |        |      |   |     |     |       |     |     |        |        |      |      |  |     |  |    |     |   |    |     |   |    |     |   |    |     |   |    |       |   |        |  |      |  |  |      |
| 1:   | 10.0   | →     |       |   |    |       |   |        |      |      |    |     |       |   |       |      |        |     |      |    |        |      |   |     |     |       |     |     |        |        |      |      |  |     |  |    |     |   |    |     |   |    |     |   |    |     |   |    |       |   |        |  |      |  |  |      |
| 2:   | 8.7  | ↘     |       |   |    |       |   |        |      |      |    |     |       |   |       |      |        |     |      |    |        |      |   |     |     |       |     |     |        |        |      |      |  |     |  |    |     |   |    |     |   |    |     |   |    |     |   |    |       |   |        |  |      |  |  |      |
| Series   |  | 18.7  |       |   |    |       |   |        |      |      |    |     |       |   |       |      |        |     |      |    |        |      |   |     |     |       |     |     |        |        |      |      |  |     |  |    |     |   |    |     |   |    |     |   |    |     |   |    |       |   |        |  |      |  |  |      |
|  |  | 153.3 |       |   |    |       |   |        |      |      |    |     |       |   |       |      |        |     |      |    |        |      |   |     |     |       |     |     |        |        |      |      |  |     |  |    |     |   |    |     |   |    |     |   |    |     |   |    |       |   |        |  |      |  |  |      |
|  <p>6. Series Finals</p> | <table border="1" style="width:100%; border-collapse: collapse;"> <tr><td>1:</td><td>10.4x</td><td>→</td></tr> <tr><td>2:</td><td>10.0</td><td>↗</td></tr> <tr><td colspan="2">Series</td><td>20.4</td></tr> <tr><td colspan="2"></td><td>173.7</td></tr> </table>   | 1:    | 10.4x | → | 2: | 10.0  | ↗ | Series |      | 20.4 |    |     | 173.7 |  <p>7. Series Finals</p> <table border="1" style="width:100%; border-collapse: collapse;"> <tr><td>1:</td><td>8.7</td><td>←</td></tr> <tr><td>2:</td><td>9.6</td><td>→</td></tr> <tr><td colspan="2">Series</td><td>18.3</td></tr> <tr><td colspan="2"></td><td>192.0</td></tr> </table>  | 1:    | 8.7  | ←      | 2:  | 9.6  | →  | Series |      | 18.3  |     |     | 192.0 |     |     |        |        |      |      |  |     |  |    |     |   |    |     |   |    |     |   |    |     |   |    |       |   |        |  |      |  |  |      |
| 1:   | 10.4x  | →     |       |   |    |       |   |        |      |      |    |     |       |   |       |      |        |     |      |    |        |      |   |     |     |       |     |     |        |        |      |      |  |     |  |    |     |   |    |     |   |    |     |   |    |     |   |    |       |   |        |  |      |  |  |      |
| 2:   | 10.0   | ↗     |       |   |    |       |   |        |      |      |    |     |       |   |       |      |        |     |      |    |        |      |   |     |     |       |     |     |        |        |      |      |  |     |  |    |     |   |    |     |   |    |     |   |    |     |   |    |       |   |        |  |      |  |  |      |
| Series   |  | 20.4  |       |   |    |       |   |        |      |      |    |     |       |   |       |      |        |     |      |    |        |      |   |     |     |       |     |     |        |        |      |      |  |     |  |    |     |   |    |     |   |    |     |   |    |     |   |    |       |   |        |  |      |  |  |      |
|  |  | 173.7 |       |   |    |       |   |        |      |      |    |     |       |   |       |      |        |     |      |    |        |      |   |     |     |       |     |     |        |        |      |      |  |     |  |    |     |   |    |     |   |    |     |   |    |     |   |    |       |   |        |  |      |  |  |      |
| 1:   | 8.7  | ←     |       |   |    |       |   |        |      |      |    |     |       |   |       |      |        |     |      |    |        |      |   |     |     |       |     |     |        |        |      |      |  |     |  |    |     |   |    |     |   |    |     |   |    |     |   |    |       |   |        |  |      |  |  |      |
| 2:   | 9.6  | →     |       |   |    |       |   |        |      |      |    |     |       |   |       |      |        |     |      |    |        |      |   |     |     |       |     |     |        |        |      |      |  |     |  |    |     |   |    |     |   |    |     |   |    |     |   |    |       |   |        |  |      |  |  |      |
| Series   |  | 18.3  |       |   |    |       |   |        |      |      |    |     |       |   |       |      |        |     |      |    |        |      |   |     |     |       |     |     |        |        |      |      |  |     |  |    |     |   |    |     |   |    |     |   |    |     |   |    |       |   |        |  |      |  |  |      |
|  |  | 192.0 |       |   |    |       |   |        |      |      |    |     |       |   |       |      |        |     |      |    |        |      |   |     |     |       |     |     |        |        |      |      |  |     |  |    |     |   |    |     |   |    |     |   |    |     |   |    |       |   |        |  |      |  |  |      |

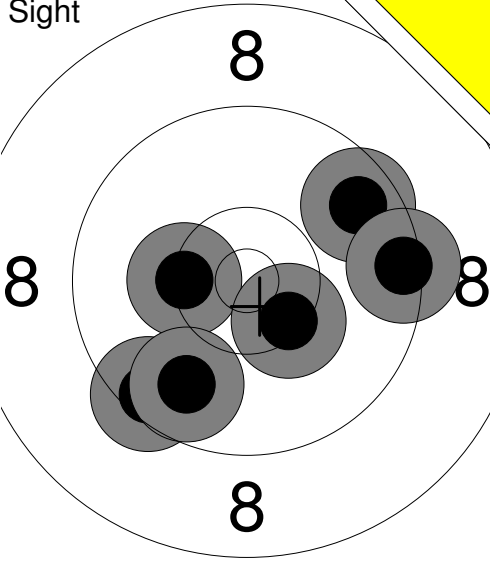
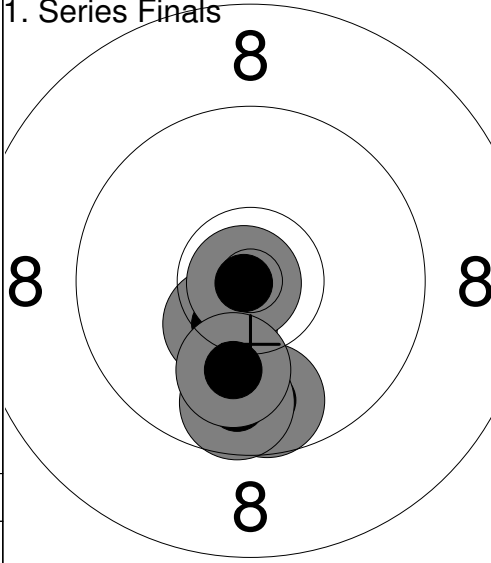
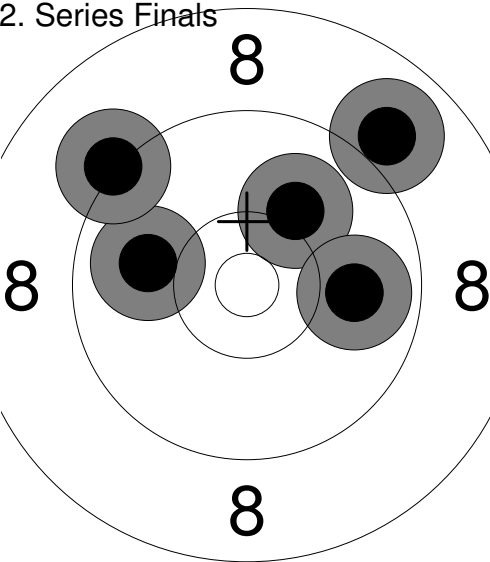
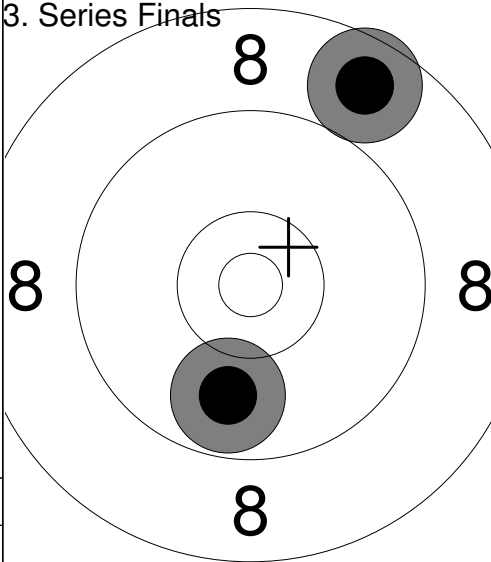
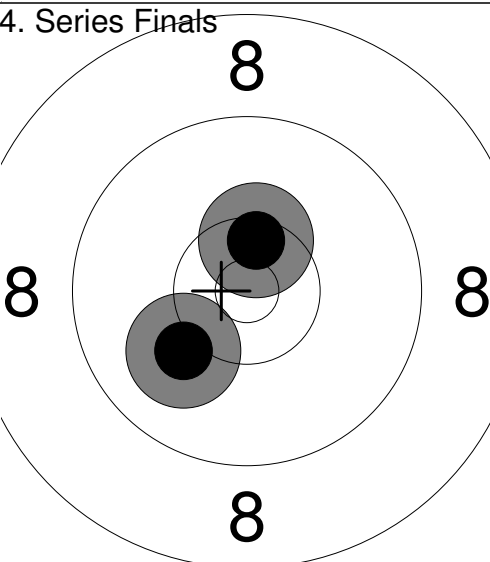
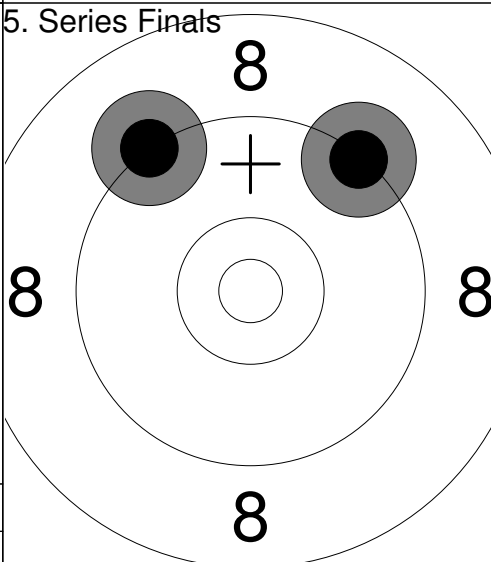
|  |  |   |
|--|--|---|
| <p>Sight</p>               | <p>1: 9.5 ↙<br/>2: 9.6 ↗<br/>3: 9.4 →<br/>4: 10.3 ←<br/>5: 10.4x ↘<br/>6: 9.8 ↙</p> <p>Series 59.0<br/>0.0</p> | <p>1. Series Finals</p>  <p>1: 9.8 ↓<br/>2: 9.7 ↓<br/>3: 10.4x ↙<br/>4: 10.9x ←<br/>5: 10.1 ↓</p> <p>Series 50.9<br/>50.9</p> |
| <p>2. Series Finals</p>   | <p>1: 10.0 ←<br/>2: 9.2 ↖<br/>3: 8.9 ↗<br/>4: 10.1 ↗<br/>5: 9.9 →</p> <p>Series 48.1<br/>99.0</p>              | <p>3. Series Finals</p>  <p>1: 8.7 ↗<br/>2: 9.8 ↓</p> <p>Series 18.5<br/>117.5</p>   |
| <p>4. Series Finals</p>  | <p>1: 10.1 ↙<br/>2: 10.4x ↑</p> <p>Series 20.5<br/>138.0</p>   | <p>5. Series Finals</p>  <p>1: 9.3 ↗<br/>2: 9.2 ↖</p> <p>Series 18.5<br/>156.5</p>  |

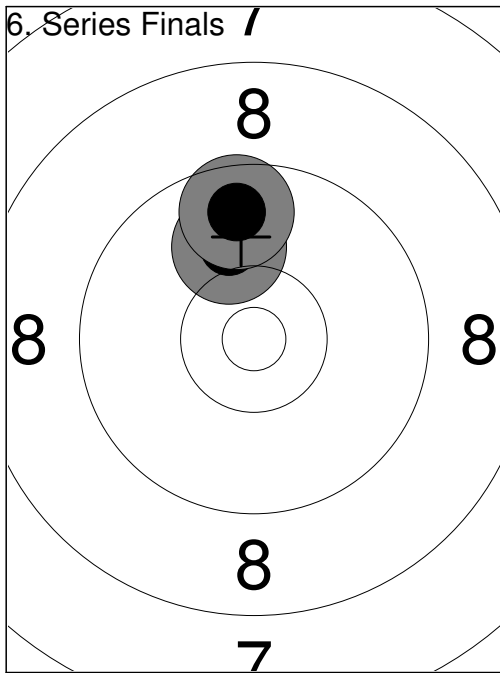

|        |       |   |
|--------|-------|---|
| 1:     | 10.0  | ↑ |
| 2:     | 9.7   | ↑ |
| Series | 19.7  |   |
|        | 176.2 |   |

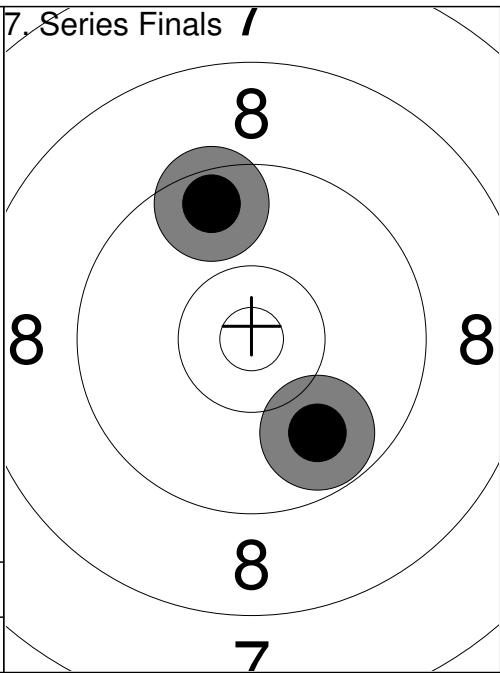

|        |       |   |
|--------|-------|---|
| 1:     | 9.8   | ↘ |
| 2:     | 9.6   | ↑ |
| Series | 19.4  |   |
|        | 195.6 |   |

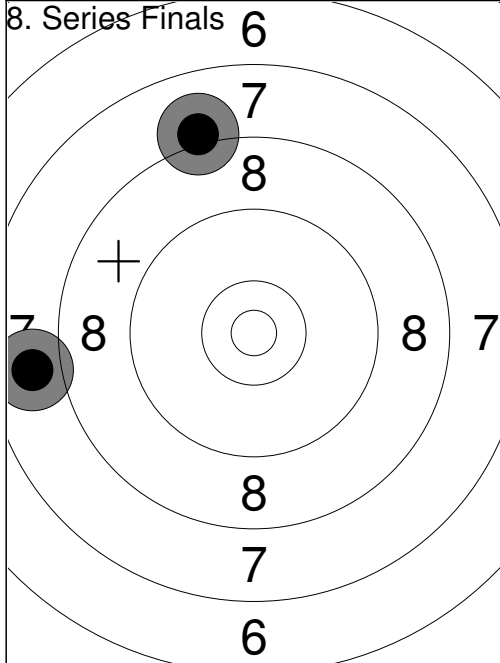

|        |       |   |
|--------|-------|---|
| 1:     | 8.1   | ↑ |
| 2:     | 7.8   | ← |
| Series | 15.9  |   |
|        | 211.5 |   |

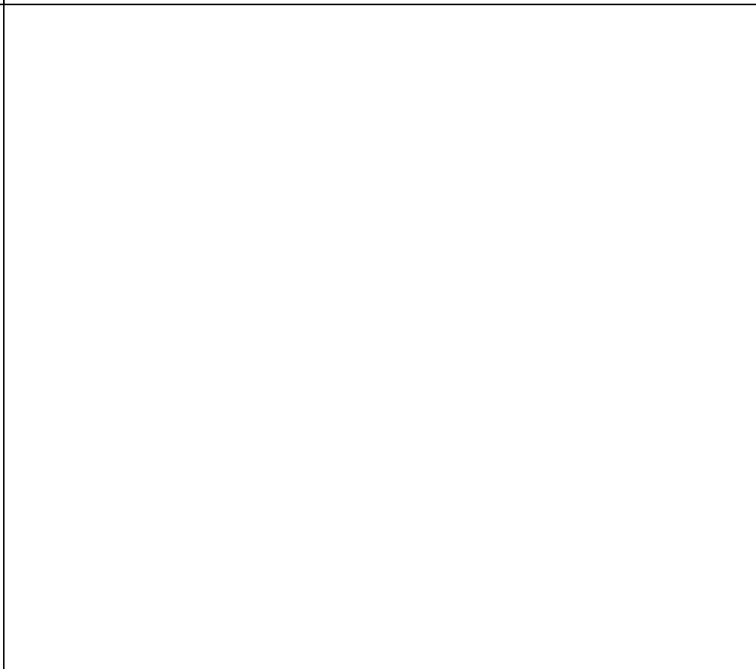
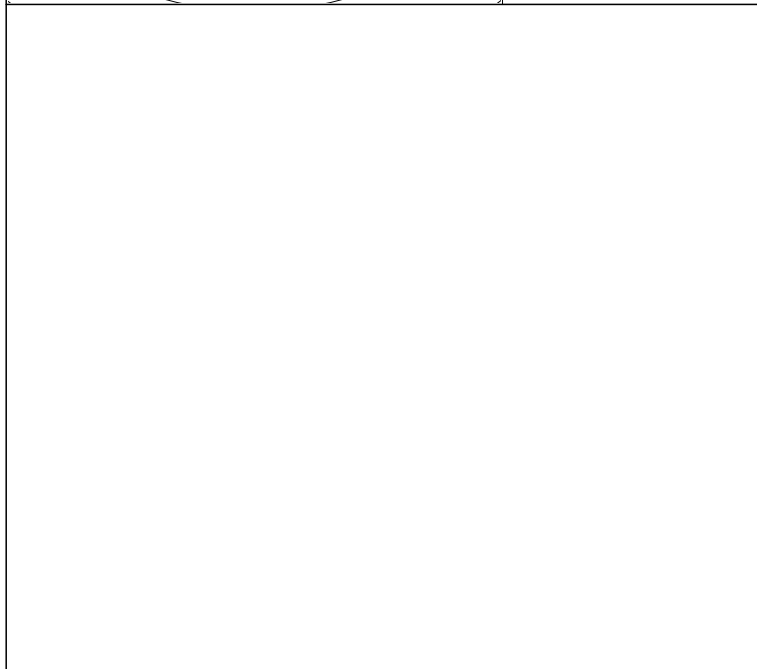

|                   |                   |                       |
|-------------------|-------------------|-----------------------|
| Relay<br><b>1</b> | Lane<br><b>17</b> | <b>VASILEVA Yanka</b> |
|-------------------|-------------------|-----------------------|

|                           |    |   |    |
|---------------------------|----|---|----|
| 2023 SFC Pistol Nationals | QC | F | WP |
|---------------------------|----|---|----|

|            |                      |                             |
|------------|----------------------|-----------------------------|
| 16.07.2023 | 2023 PN AP60W Finals | Alberta Handgun Association |
|------------|----------------------|-----------------------------|

|         |           |
|---------|-----------|
| Comment | Signature |
|---------|-----------|

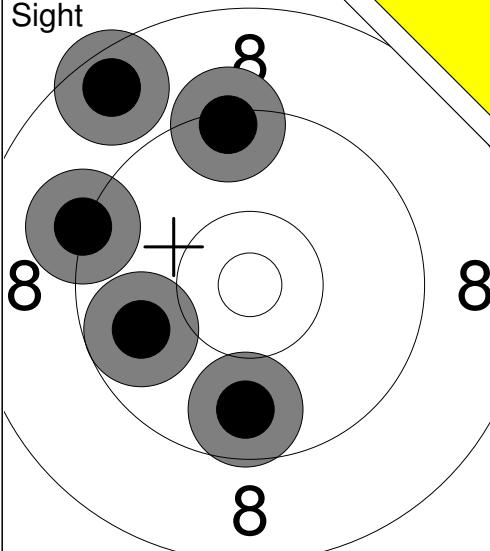
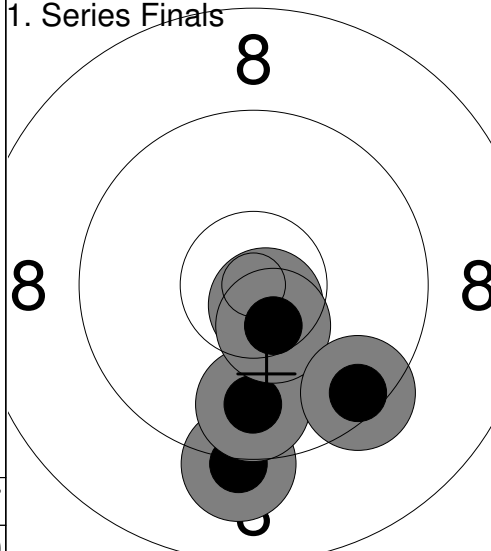
|   |  |   |
|---|--|---|
| <p>Sight</p>  | <p>1. Series Finals</p>  | <p>1: 9.2 ↙<br/>2: 8.6 ↗<br/>3: 9.4 ↑<br/>4: 9.8 ←<br/>5: 9.7 ↓</p>     |
| <p>Series 46.7</p> <p>0.0</p>   | <p>Series 49.7</p> <p>49.7</p>   | <p>1: 9.2 ↓<br/>2: 10.7x ↘<br/>3: 9.8 ↓<br/>4: 10.5x ↘<br/>5: 9.5 ↘</p> |

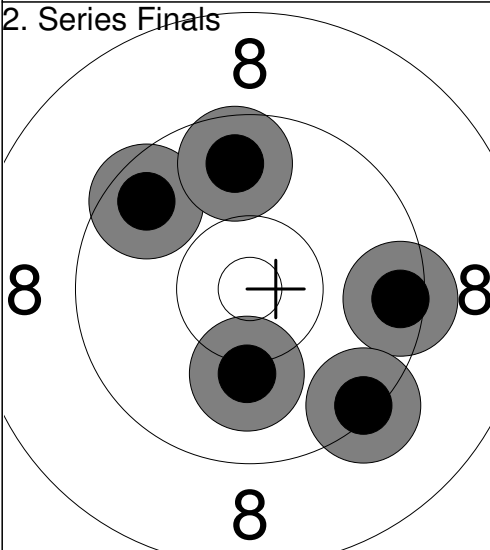
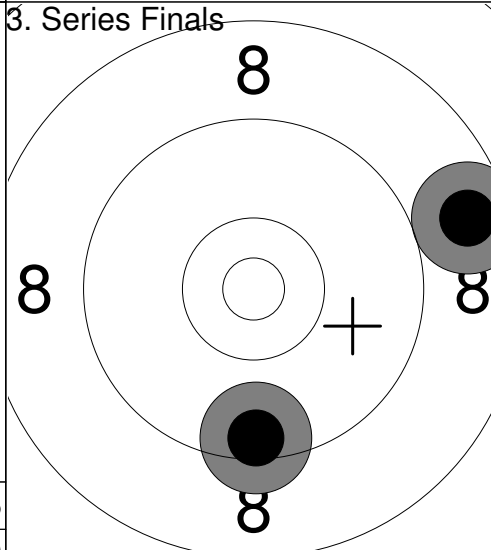
|   |   |  |
|---|---|--|
| <p>2. Series Finals</p>  | <p>3. Series Finals</p>  | <p>1: 9.6 ↗<br/>2: 9.7 ↑<br/>3: 10.1 ↓<br/>4: 9.5 →<br/>5: 9.4 ↘</p> |
| <p>Series 48.3</p> <p>98.0</p>  | <p>Series 18.1</p> <p>116.1</p>   | <p>1: 8.7 →<br/>2: 9.4 ↓</p>   |

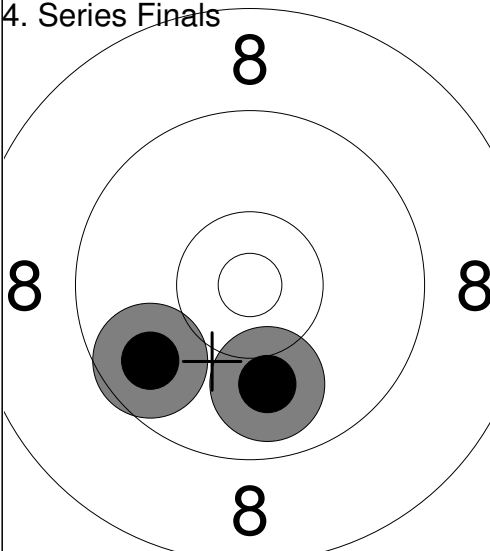
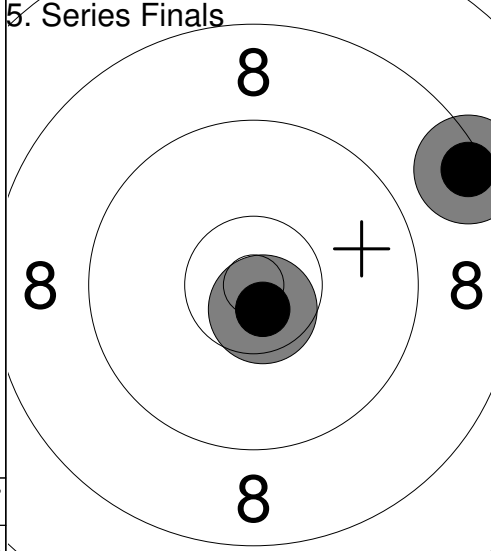
|  |  |                                |
|--|--|--------------------------------|
| <p>4. Series Finals</p>  | <p>5. Series Finals</p>  | <p>1: 10.0 ↓<br/>2: 9.7 ↙</p>  |
| <p>Series 19.7</p> <p>135.8</p>  | <p>Series 19.1</p> <p>154.9</p>  | <p>1: 8.4 →<br/>2: 10.7x ↘</p> |

6. Series Finals /

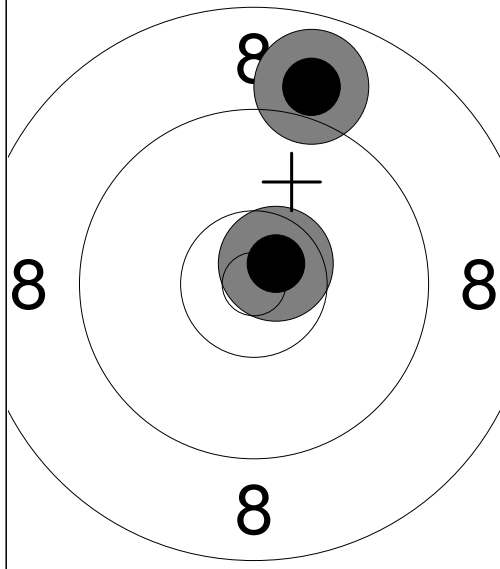

1: 8.9 ↗  
2: 10.7x ↗

Series 19.6  
174.5

7. Series Finals /

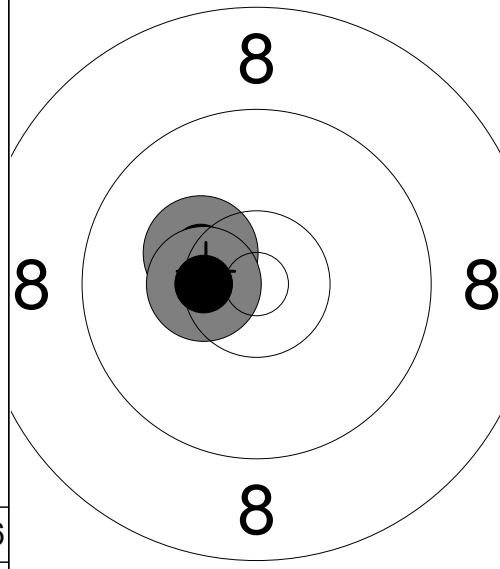

1: 10.3 ↖  
2: 10.4x ←

Series 20.7  
195.2

8. Series Finals /

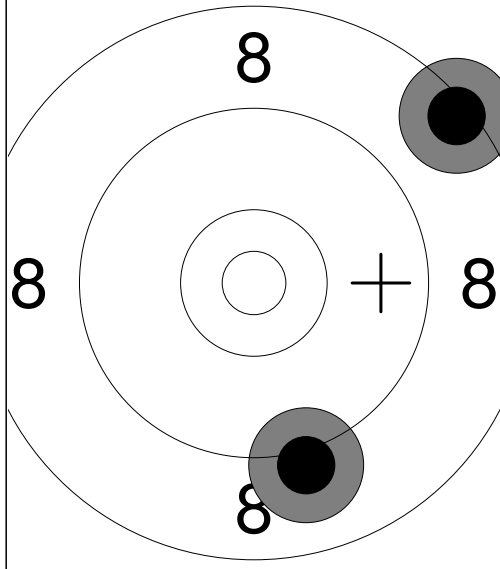

1: 8.4 ↗  
2: 9.1 ↓

Series 17.5  
212.7

9. Series Finals /

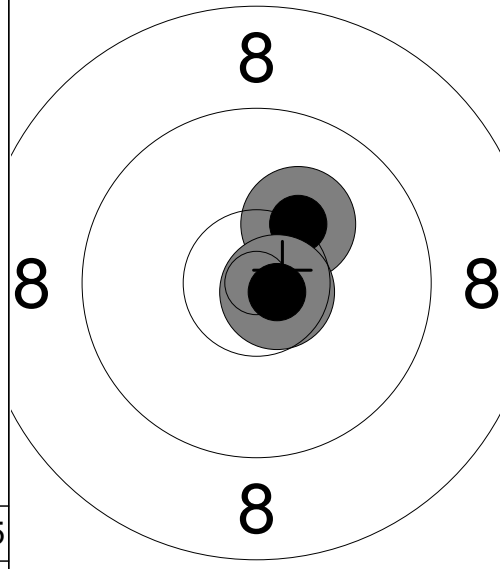

1: 10.2 ↗  
2: 10.7x ↘

Series 20.9  
233.6



|                   |                   |                      |
|-------------------|-------------------|----------------------|
| Relay<br><b>1</b> | Lane<br><b>18</b> | <b>GUSTAFSON Liz</b> |
|-------------------|-------------------|----------------------|

|                           |    |   |    |
|---------------------------|----|---|----|
| 2023 SFC Pistol Nationals | AB | F | WP |
|---------------------------|----|---|----|

|            |                      |                             |
|------------|----------------------|-----------------------------|
| 16.07.2023 | 2023 PN AP60W Finals | Alberta Handgun Association |
|------------|----------------------|-----------------------------|

|         |           |
|---------|-----------|
| Comment | Signature |
|---------|-----------|

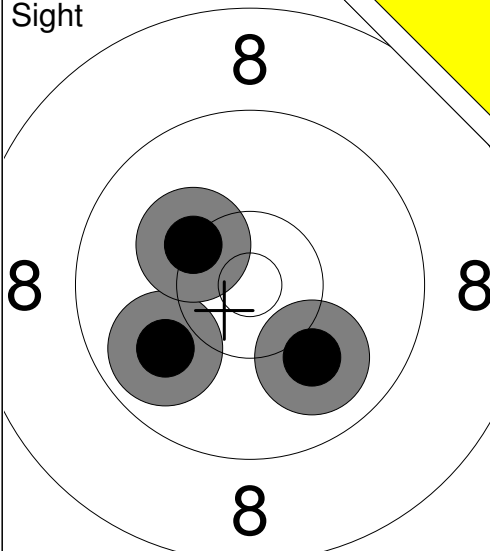
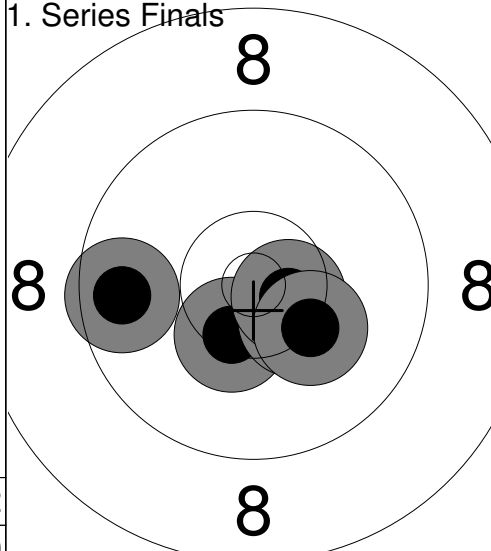
|   |  |   |
|---|--|---|
| <p>Sight</p>  | <p>1: 10.0 ↘<br/>2: 9.9 ↙<br/>3: 10.3 ↖</p> <p>Series 30.2<br/>0.0</p> | <p>1. Series Finals</p>  <p>1: 9.7 ←<br/>2: 10.4x ↘<br/>3: 10.4x ↘<br/>4: 10.6x →<br/>5: 10.2 ↘</p> <p>Series 51.3<br/>51.3</p> |
|---|--|---|

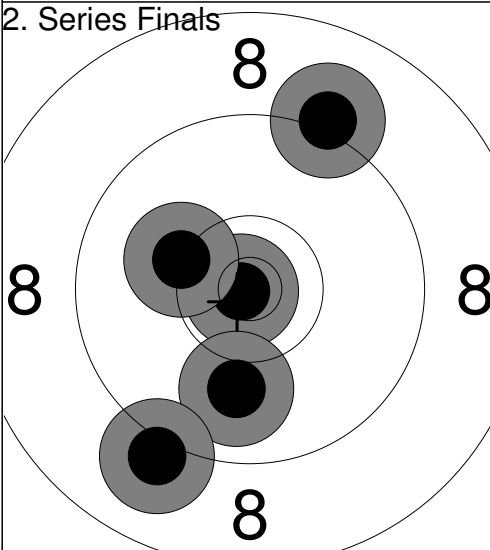
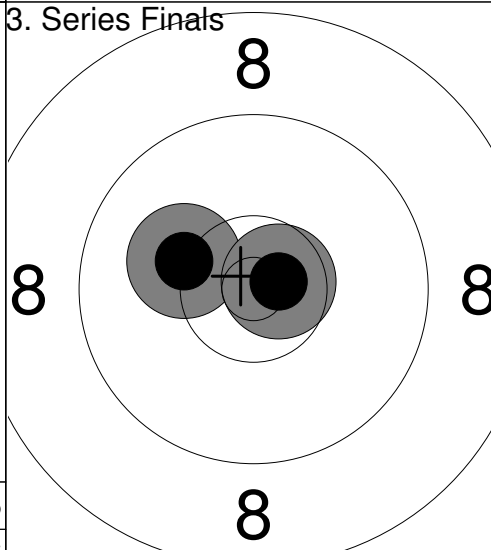
|   |  |  |
|---|--|--|
| <p>2. Series Finals</p>  | <p>1: 10.9x ←<br/>2: 10.0 ↓<br/>3: 9.1 ↘<br/>4: 9.1 ↗<br/>5: 10.2 ↖</p> <p>Series 49.3<br/>100.6</p> | <p>3. Series Finals</p>  <p>1: 10.2 ↖<br/>2: 10.7x →</p> <p>Series 20.9<br/>121.5</p> |
|---|--|--|

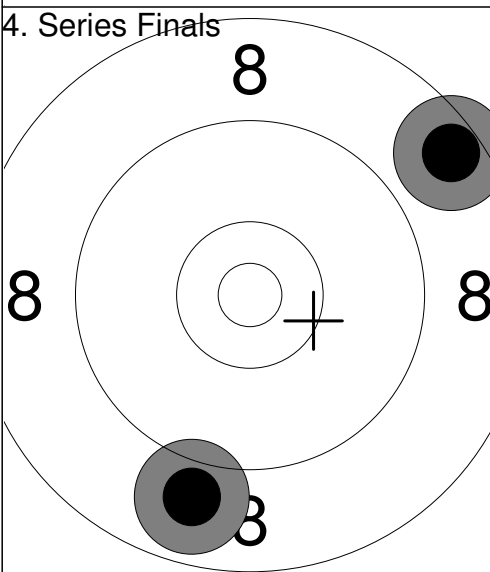
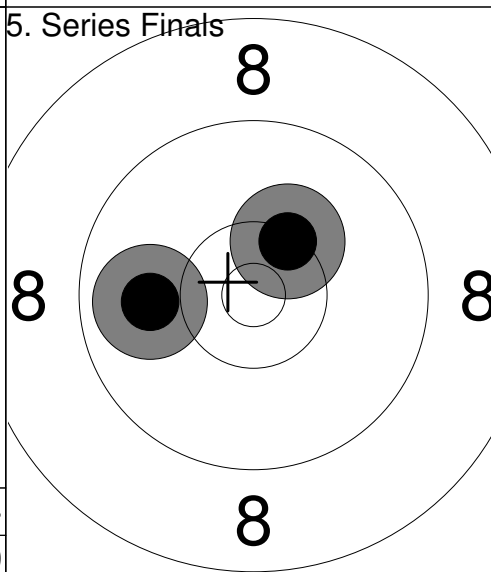
|  |   |   |
|--|---|---|
| <p>4. Series Finals</p>  | <p>1: 8.5 ↗<br/>2: 8.9 ↓</p> <p>Series 17.4<br/>138.9</p> | <p>5. Series Finals</p>  <p>1: 10.3 ↗<br/>2: 9.9 ←</p> <p>Series 20.2<br/>159.1</p> |
|--|---|---|

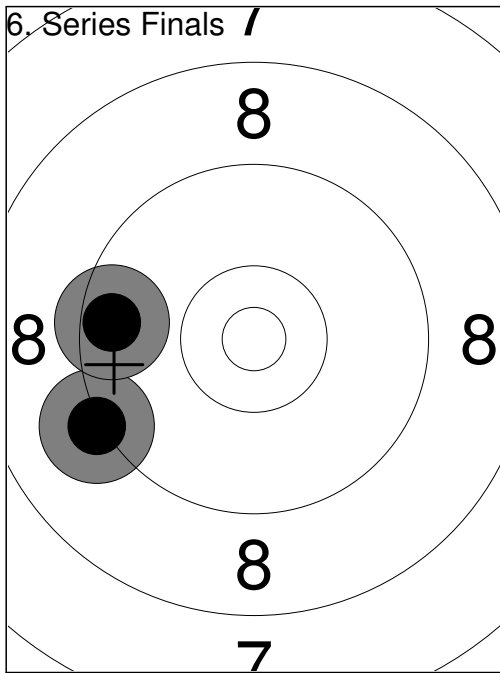

|        |       |   |
|--------|-------|---|
| 1:     | 9.2   | ↙ |
| 2:     | 9.5   | ← |
| Series | 18.7  |   |
|        | 177.8 |   |

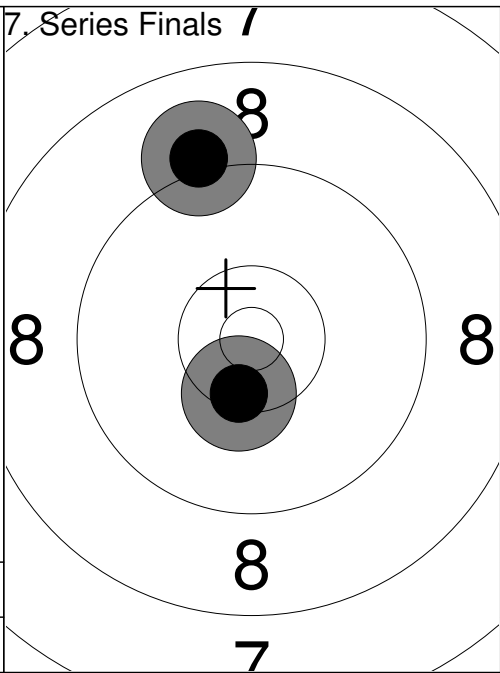

|        |       |   |
|--------|-------|---|
| 1:     | 10.4x | ↘ |
| 2:     | 9.1   | ↗ |
| Series | 19.5  |   |
|        | 197.3 |   |

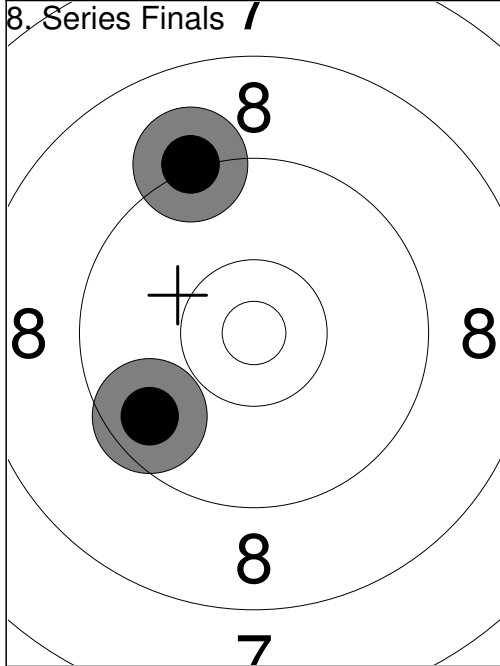

|        |       |   |
|--------|-------|---|
| 1:     | 9.6   | ↙ |
| 2:     | 9.2   | ↗ |
| Series | 18.8  |   |
|        | 216.1 |   |

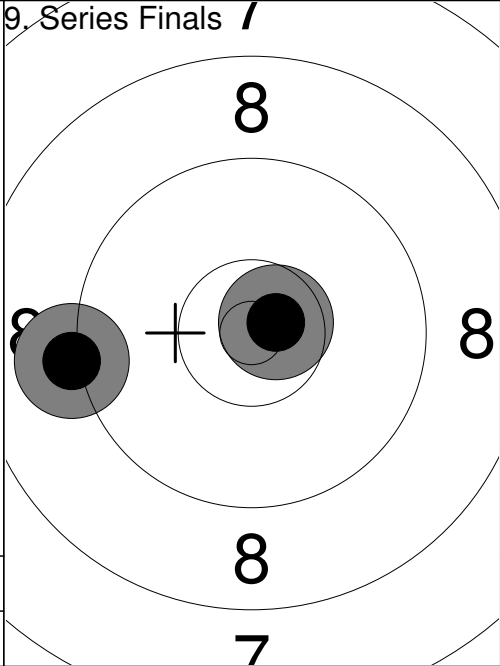

|        |       |   |
|--------|-------|---|
| 1:     | 9.2   | ← |
| 2:     | 10.7x | ↘ |
| Series | 19.9  |   |
|        | 236.0 |   |

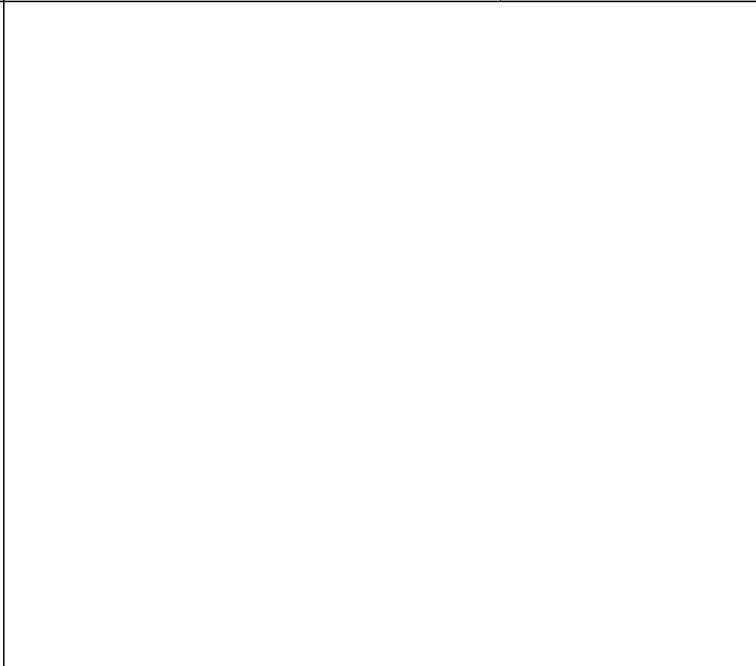

|                   |                   |                  |
|-------------------|-------------------|------------------|
| Relay<br><b>1</b> | Lane<br><b>19</b> | <b>SONG Miya</b> |
|-------------------|-------------------|------------------|

|                              |   |    |
|------------------------------|---|----|
| 2023 SFC Pistol Nationals BC | F | WP |
|------------------------------|---|----|

|            |                      |                             |
|------------|----------------------|-----------------------------|
| 16.07.2023 | 2023 PN AP60W Finals | Alberta Handgun Association |
|------------|----------------------|-----------------------------|

|         |           |
|---------|-----------|
| Comment | Signature |
|---------|-----------|

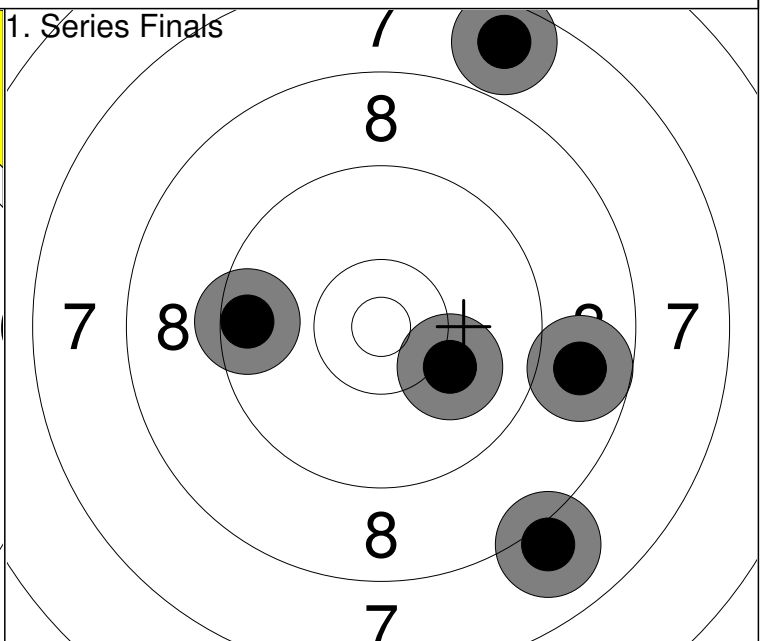
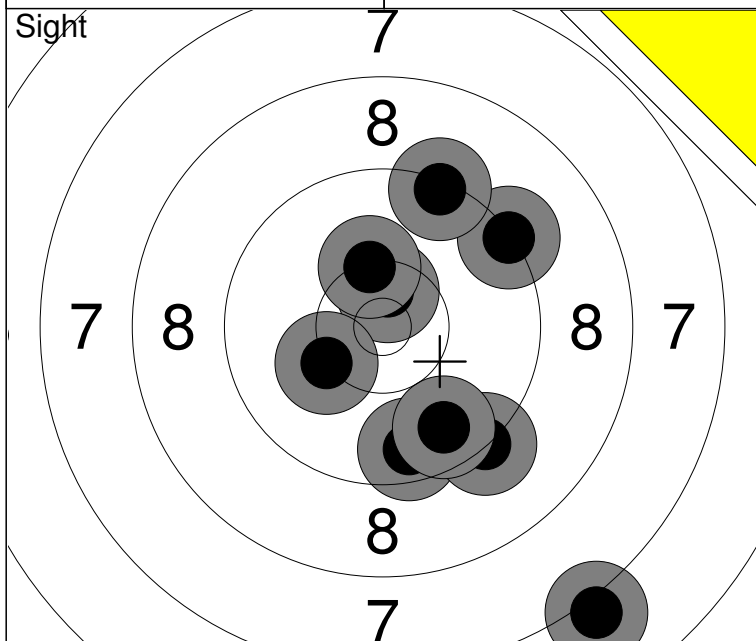

|          |   |
|----------|---|
| 1: 9.6   | ↓ |
| 2: 9.3   | ↓ |
| 3: 9.7   | ↓ |
| 4: 10.6x | ↑ |
| 5: 7.1   | ↓ |

|         |   |
|---------|---|
| 6: 10.3 | ↑ |
| 7: 9.3  | ↗ |
| 8: 9.3  | ↑ |
| 9: 10.2 | ↙ |

|        |      |
|--------|------|
| Series | 85.4 |
|        | 0.0  |

|         |   |
|---------|---|
| 1: 7.6  | ↑ |
| 2: 10.1 | ↘ |
| 3: 9.5  | ← |
| 4: 8.8  | → |
| 5: 8.0  | ↓ |

|        |      |
|--------|------|
| Series | 44.0 |
|        | 44.0 |

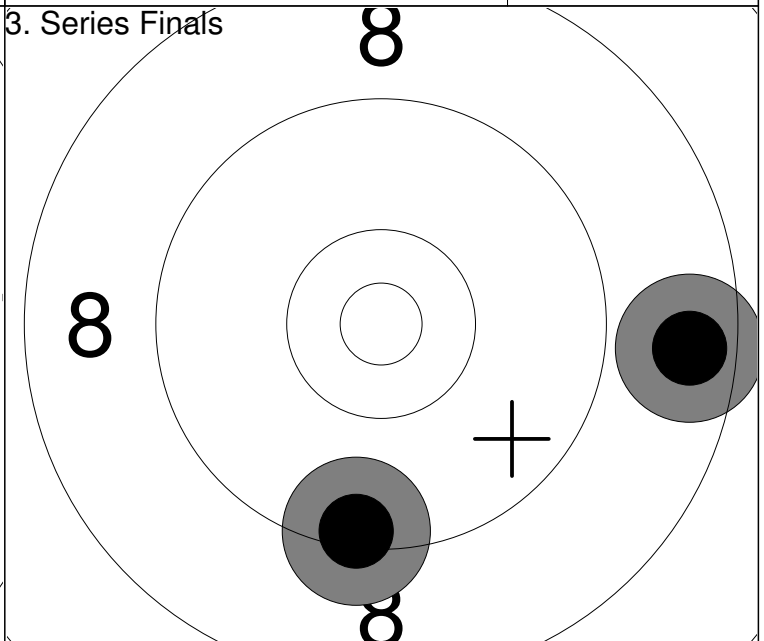
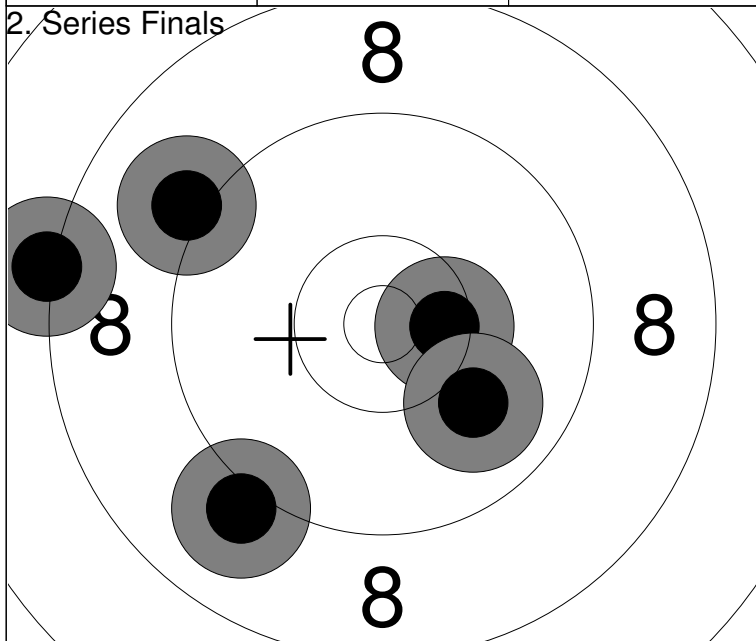

|          |   |
|----------|---|
| 1: 9.1   | ↘ |
| 2: 8.2   | ← |
| 3: 10.4x | → |
| 4: 10.0  | ↘ |
| 5: 9.1   | ↗ |

|        |      |
|--------|------|
| Series | 46.8 |
|        | 90.8 |

|        |   |
|--------|---|
| 1: 8.6 | → |
| 2: 9.4 | ↓ |

|        |       |
|--------|-------|
| Series | 18.0  |
|        | 108.8 |