

Relay 1	Lane 13	NORMAN Rex
-------------------	-------------------	-------------------

2023 SFC Pistol Nationals SK	JR	MP
------------------------------	----	----

14.07.2023	23PNRF2S1	Alberta Handgun Association
------------	-----------	-----------------------------

Comment	Signature
---------	-----------

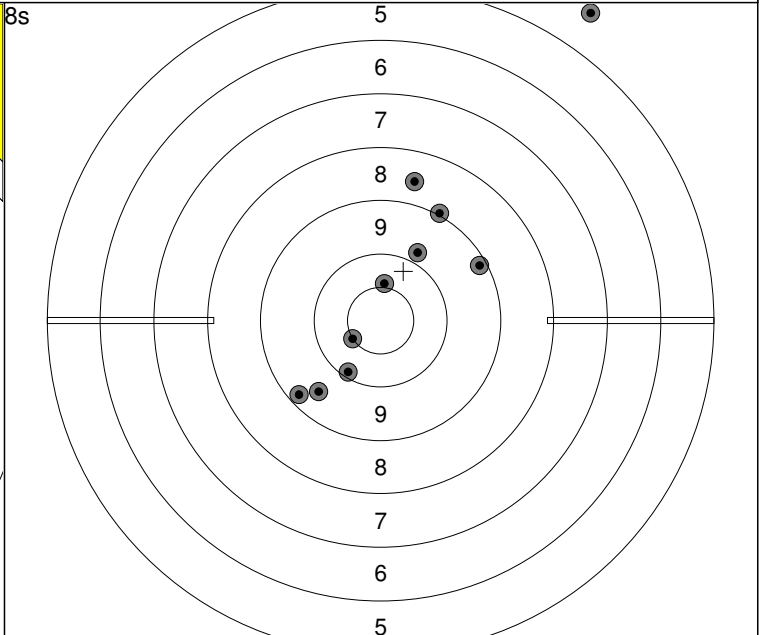
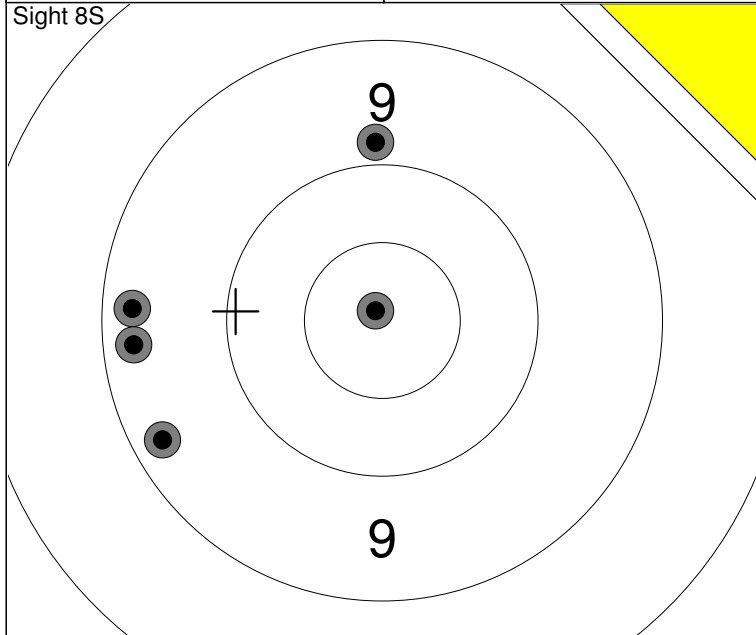

1: 2.39s 10.9x ↖
2: 3.22s 9.3 ←
3: 4.18s 9.3 ↙
4: 5.19s 9.8 ↑
5: 6.53s 9.3 ←

Series	46 (1x)
	0 (0x)

1: 2.02s 9.8 ↗
2: 3.05s 8.6 ↑
3: 4.08s 9.1 ↗
4: 5.46s 10.4 ↑
5: 6.54s 9.5 ↘

1: 2.97s 10.5x ↙
2: 4.37s 9.2 ↘
3: 5.27s 10.1 ↘
4: 6.21s 9.0 ↗
5: 7.45s 0.0 ↗

Series	83 (1x)
	83 (1x)

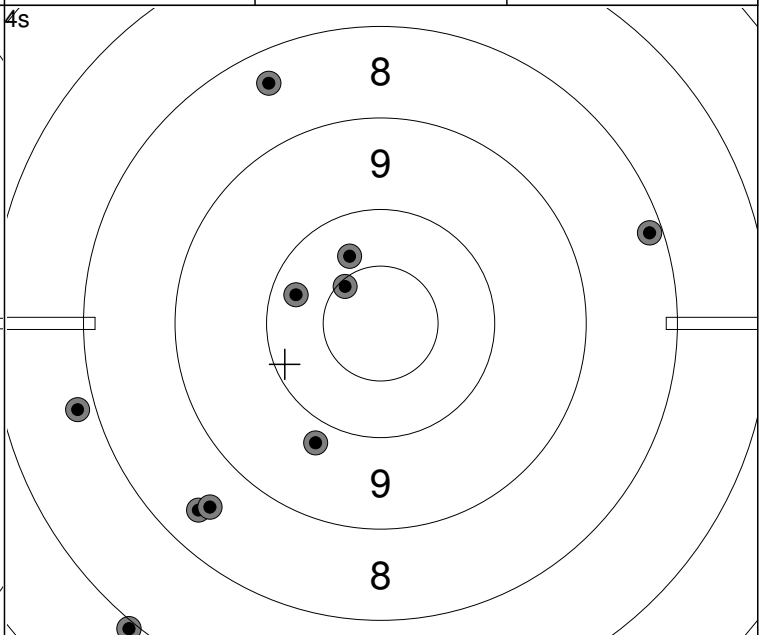
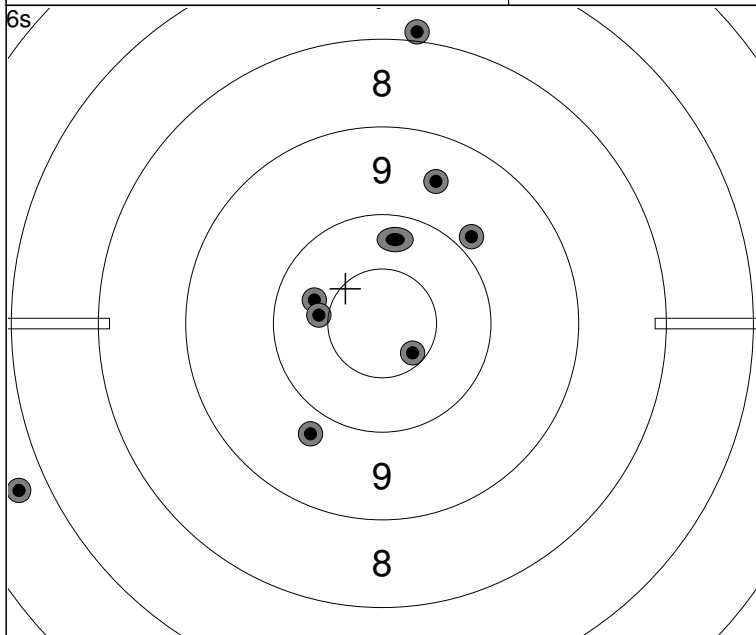

1: 2.47s 6.7 ↙
2: 3.36s 10.6x ↘
3: 4.17s 10.3 ↙
4: 4.82s 10.4 ←
5: --

1: 2.77s 9.8 ↗
2: 3.79s 7.9 ↑
3: 4.74s 9.5 ↑
4: 5.59s 9.8 ↘
5: 0.05s ↘

Series	70 (1x)
	153 (2x)

1: 1.83s 8.4 ↗
2: 2.36s 7.8 ←
3: 2.84s 6.9 ↘
4: 3.20s 10.5x ↘
5: 3.60s 8.4 ↘

1: 1.61s 10.3 ↗
2: 2.10s 10.2 ←
3: 2.57s 9.8 ↘
4: 3.09s 8.2 →
5: 3.64s 8.5 ↘

Series	84 (1x)
	237 (3x)

Relay 1	Lane 23	NORMAN Seth
-------------------	-------------------	--------------------

2023 SFC Pistol Nationals SK	IJ	MP
------------------------------	----	----

14.07.2023	23PNRF2S1	Alberta Handgun Association
------------	-----------	-----------------------------

Comment	Signature
---------	-----------

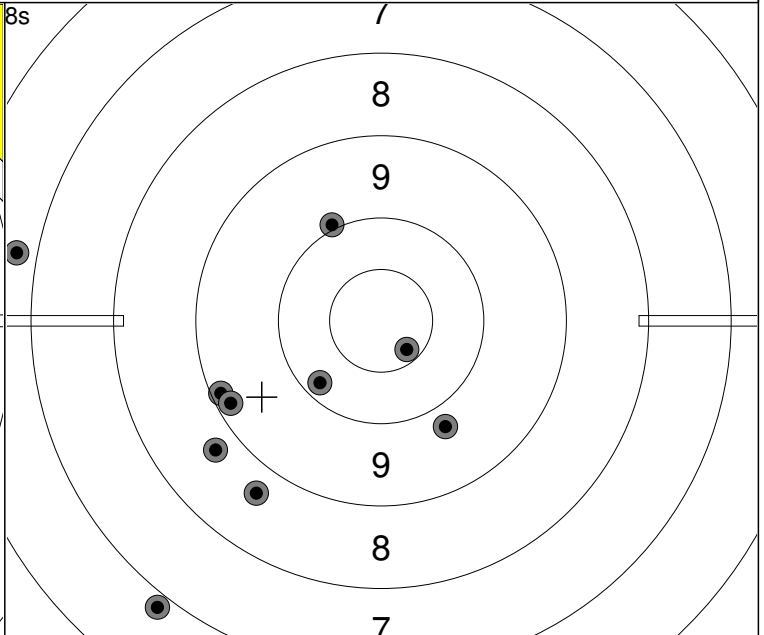
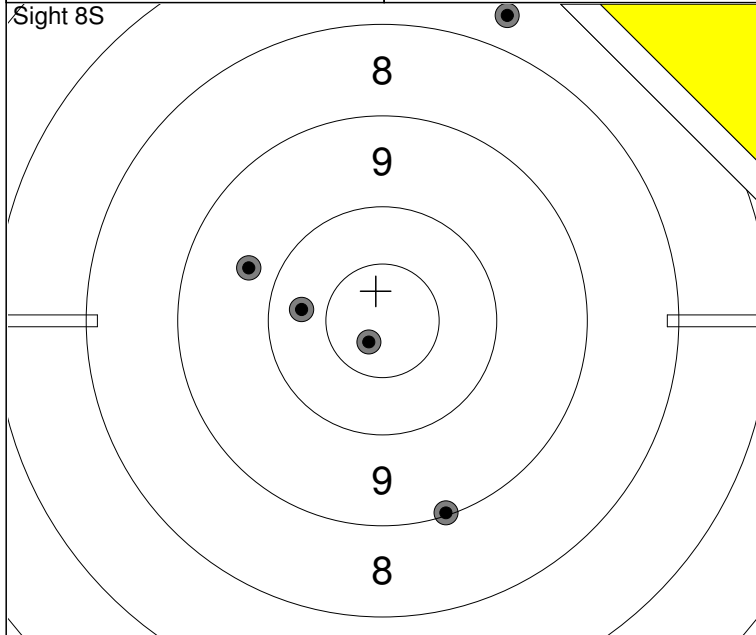

1: 2.23s 10.7x ↘
2: 3.35s 9.7 ↙
3: 4.38s 9.0 ↓
4: 5.41s 7.7 ↗
5: 6.33s 10.3 ←

Series	45 (1x)
Series	0 (0x)

1: 2.31s 9.1 ↙
2: 3.43s 9.2 ↙
3: 4.99s 9.8 ↓
4: 6.26s 6.8 ←
5: 7.38s 8.7 ↙

1: 2.67s 6.9 ↘
2: 3.88s 10.6x ↘
3: 5.36s 8.7 ↘
4: 6.74s 10.1 ↘
5: 7.82s 10.0 ↗

Series	85 (1x)
Series	85 (1x)

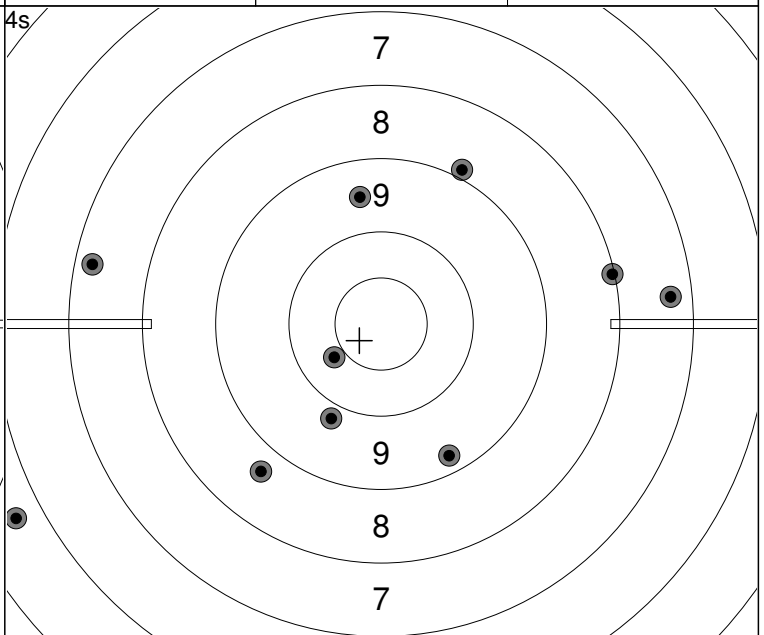
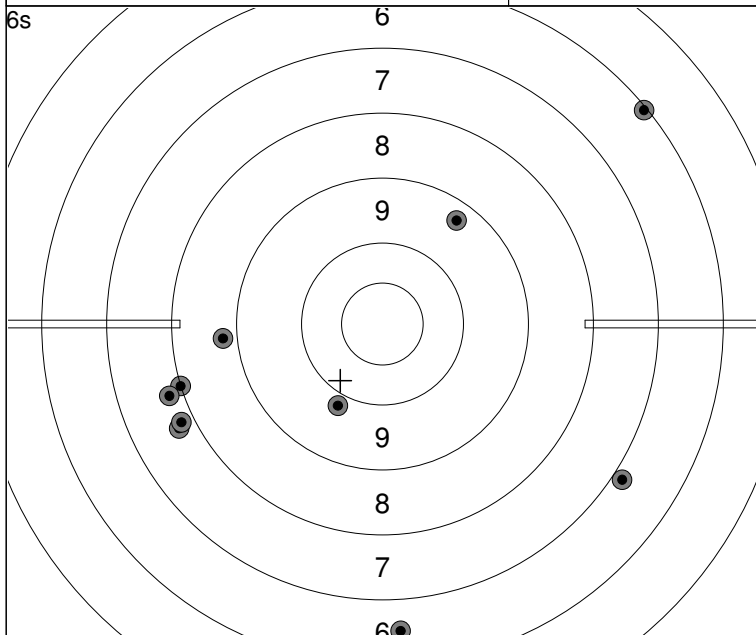

1: 1.89s 6.9 ↘
2: 2.89s 9.3 ↗
3: 3.87s 9.8 ↘
4: 4.74s 6.1 ↗
5: 5.62s 8.8 ←

1: 2.11s 6.5 ↓
2: 3.25s 7.7 ↙
3: 4.29s 8.0 ←
4: 5.19s 7.8 ↙
5: 6.06s 7.8 ↙

Series	73 (0x)
Series	158 (1x)

1: 1.78s 10.4 ↙
2: 2.38s 8.1 →
3: 2.93s 5.6 ↙
4: 3.42s 9.8 ↘
5: 4.00s 7.3 ←

1: 1.78s 9.3 ↘
2: 2.30s 8.9 ↗
3: 2.89s 9.5 ↗
4: 3.53s 8.7 ↘
5: 4.08s 7.3 →

Series	80 (0x)
Series	238 (1x)

Relay 2	Lane 3	SANDALL Jim
-------------------	------------------	--------------------

2023 SFC Pistol Nationals	MB	EX	MP
---------------------------	----	----	----

14.07.2023	23PNRF2S1	Alberta Handgun Association
------------	-----------	-----------------------------

Comment	Signature
---------	-----------

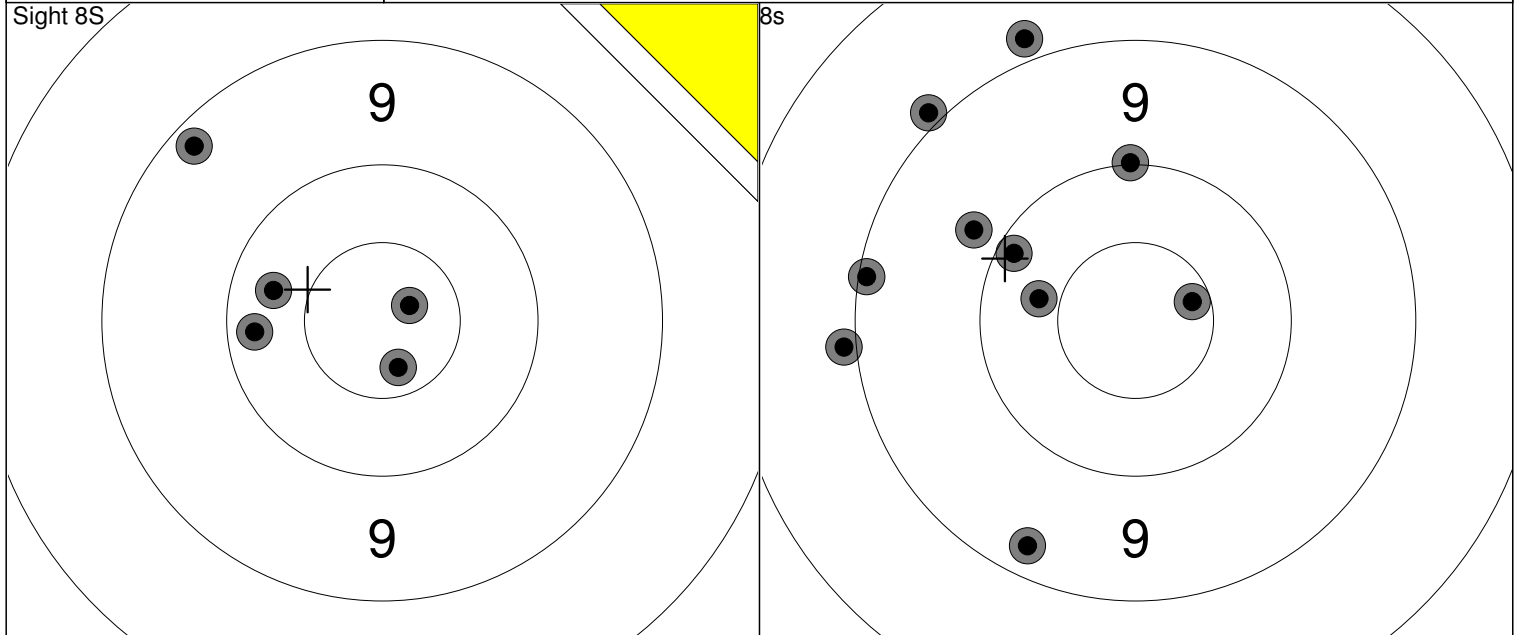

1: 2.78s 10.8x ↗ 2: 3.90s 10.7x ↓ 3: 4.85s 9.2 ↗ 4: 6.00s 10.3 ← 5: 7.23s 10.2 ←	Series 49 (2x) 0 (0x)	1: 3.10s 10.3 ← 2: 4.06s 8.9 ↗ 3: 4.97s 8.8 ↗ 4: 5.86s 10.0 ↑ 5: 6.73s 9.1 ←	Series 91 (1x) 91 (1x)
--	--------------------------------	--	---------------------------------

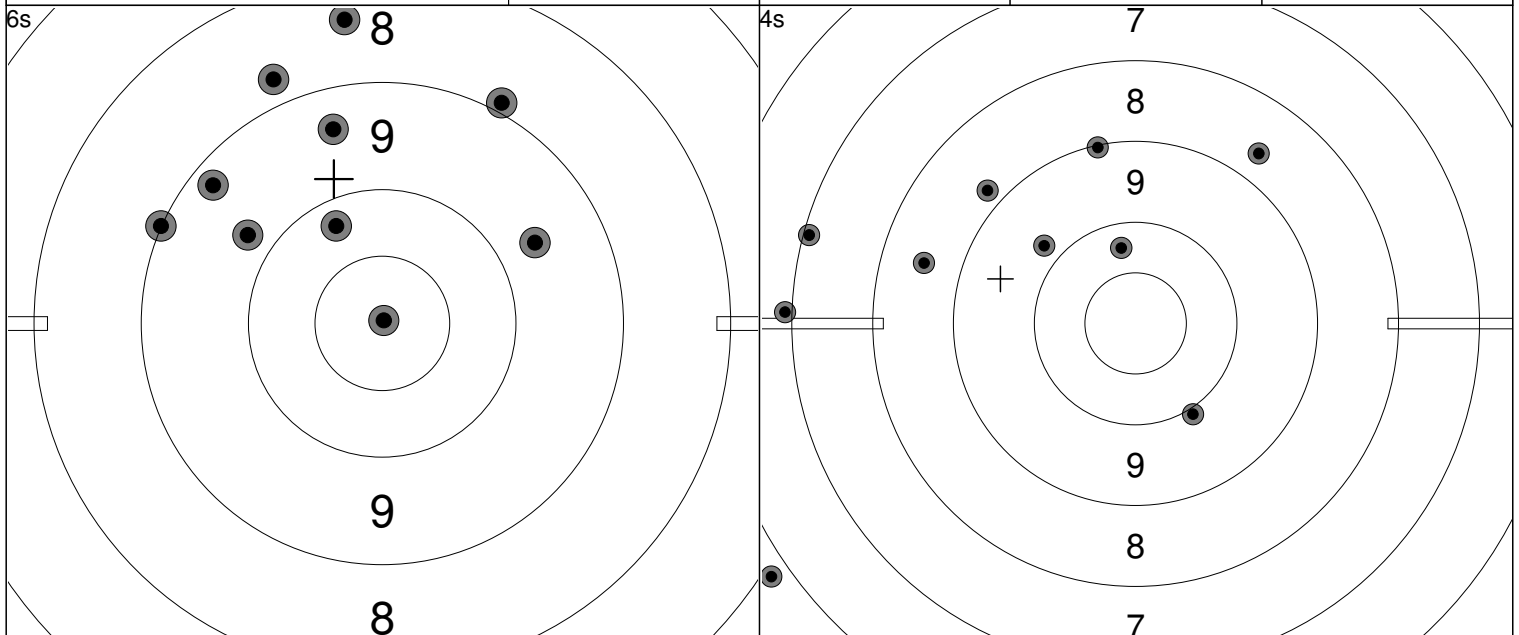

1: 2.58s 9.7 ↗ 2: 3.28s 9.8 ↖ 3: 3.89s 8.4 ↑ 4: 4.51s 8.9 ↗ 5: 5.16s 10.2 ↗	1: 2.81s 9.2 ↖ 2: 3.58s 9.4 ↑ 3: 4.22s 9.0 ↖ 4: 4.86s 10.9x ↗ 5: 5.56s 8.8 ↗	Series 89 (1x) 180 (2x)	1: 1.46s 8.7 ↗ 2: 1.98s 8.8 ↖ 3: 2.40s 7.1 ← 4: 2.82s 8.5 ← 5: 3.30s 9.0 ↑	1: 1.99s 10.2 ↑ 2: 2.51s 9.9 ↓ 3: 2.91s 5.8 ← 4: 3.35s 6.9 ← 5: 3.95s 9.8 ↗	Series 79 (0x) 259 (2x)
---	--	----------------------------------	--	---	----------------------------------

Relay 2	Lane 8	EK Nils
-------------------	------------------	----------------

2023 SFC Pistol Nationals	QC	EX	MP
---------------------------	----	----	----

14.07.2023	23PNRF2S1	Alberta Handgun Association
------------	-----------	-----------------------------

Comment	Signature
---------	-----------

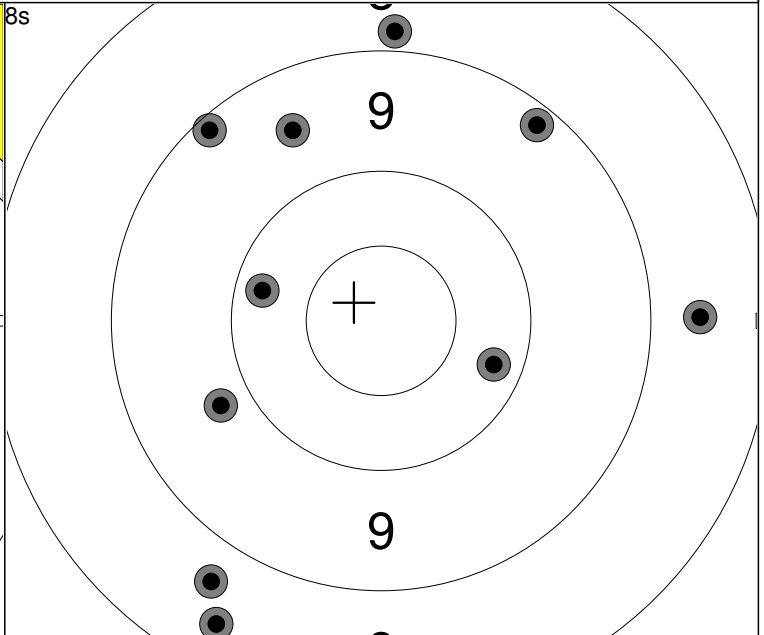
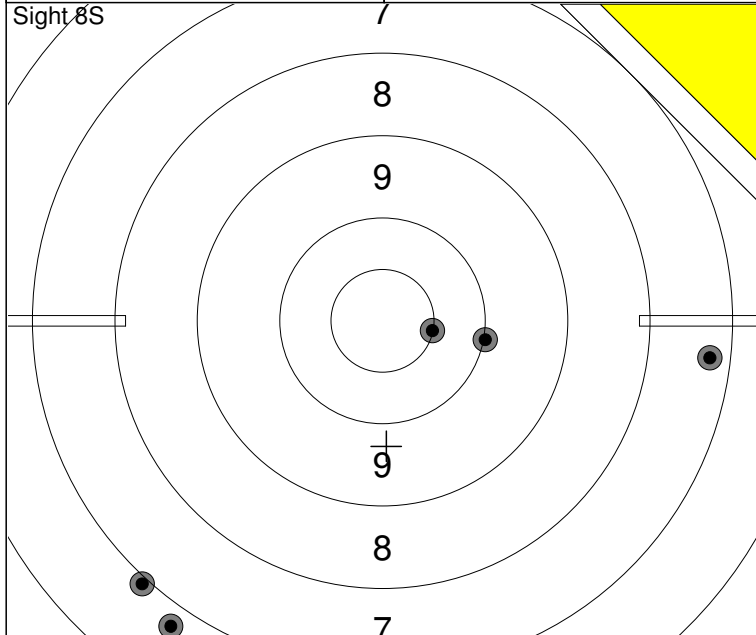

1: 2.30s	7.3	→
2: 3.40s	6.8	↘
3: 4.58s	6.9	↙
4: 5.75s	10.5x	→
5: 7.00s	10.0	→

Series	39 (1x)
	0 (0x)

1: 2.10s	8.6	→
2: 3.22s	9.2	↗
3: 4.43s	9.1	↖
4: 5.76s	9.8	↙
5: 7.24s	10.2	↘

1: 2.55s	8.4	↘
2: 3.53s	8.9	↑
3: 4.59s	9.5	↗
4: 5.66s	8.7	↘
5: 6.80s	10.2	←

Series	88 (0x)
	88 (0x)

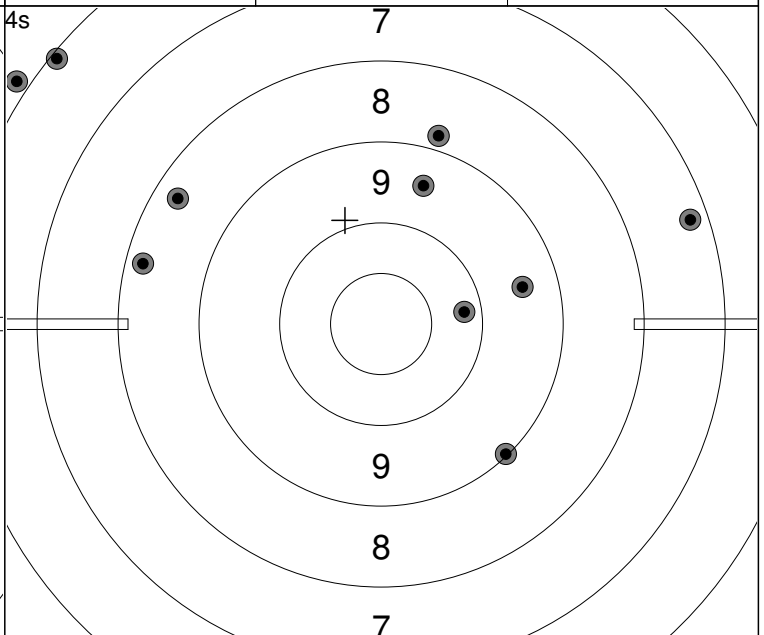
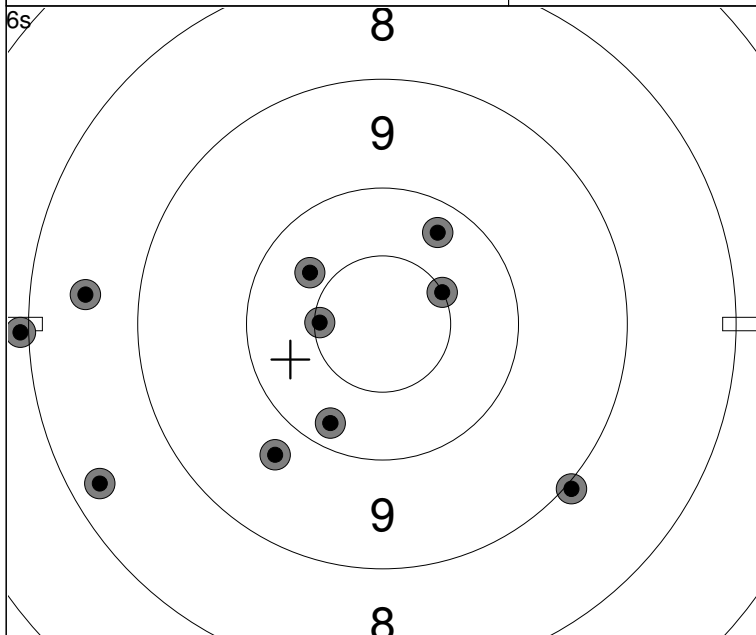

1: 1.87s	10.2	↗
2: 2.81s	7.9	←
3: 3.74s	10.2	↘
4: 4.72s	8.5	←
5: 5.63s	8.3	↙

1: 2.07s	9.0	↘
2: 3.13s	10.5x	←
3: 4.12s	10.3	↗
4: 5.04s	10.5x	↗
5: 6.04s	9.7	↘

Series	91 (2x)
	179 (2x)

1: 1.87s	9.5	→
2: 2.38s	8.3	↙
3: 2.96s	6.1	↗
4: 3.41s	9.5	↗
5: 3.79s	9.0	↘

1: 1.82s	7.2	→
2: 2.36s	5.9	↙
3: 2.95s	8.8	↑
4: 3.48s	8.2	←
5: 3.98s	10.2	→

Series	79 (0x)
	258 (2x)

Relay 2	Lane 13	KELLY Michael
-------------------	-------------------	----------------------

2023 SFC Pistol Nationals	NS	EX	MP
---------------------------	----	----	----

14.07.2023	23PNRF2S1	Alberta Handgun Association
------------	-----------	-----------------------------

Comment	Signature
---------	-----------

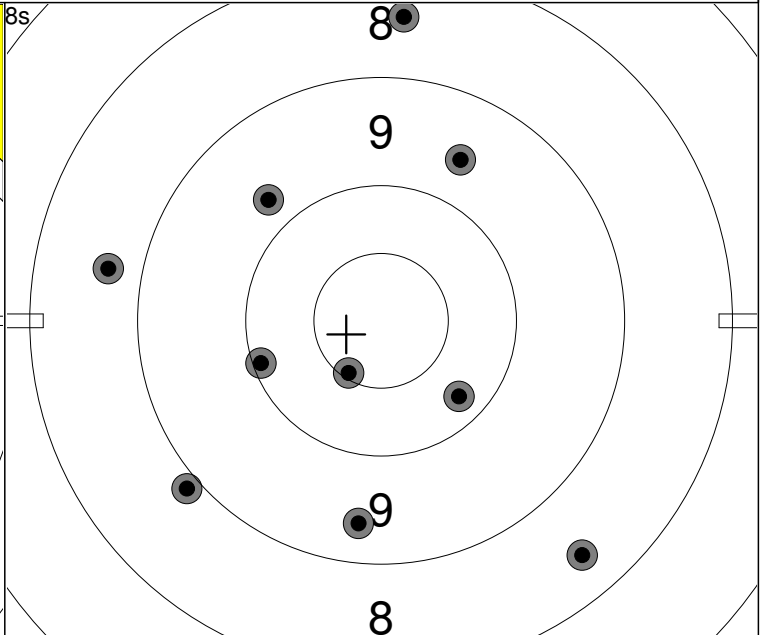
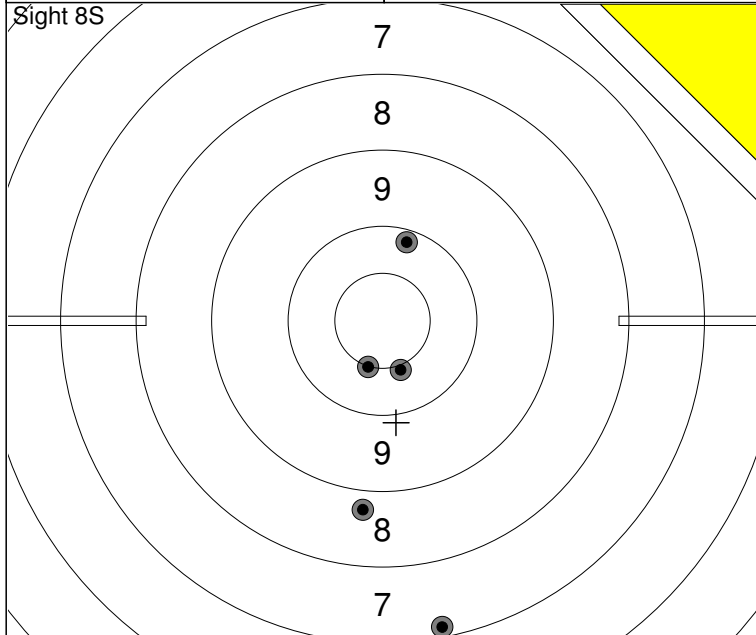

5: 3.27s 8.8	↓
4: 4.36s 7.2	↓
3: 5.18s 10.1	↑
2: 6.05s 10.4x	↓
1: 7.27s 10.5x	↓

Series	45 (2x)
Series	0 (0x)

5: 2.51s 10.5x	↙
4: 3.46s 8.4	↘
3: 4.38s 8.9	↙
2: 5.66s 8.7	←
1: 6.76s 8.5	↑

5: 2.66s 10.2	↘
4: 3.55s 9.4	↓
3: 4.40s 10.1	←
2: 5.39s 9.7	↑
1: 6.77s 9.6	↑

Series	89 (1x)
Series	89 (1x)

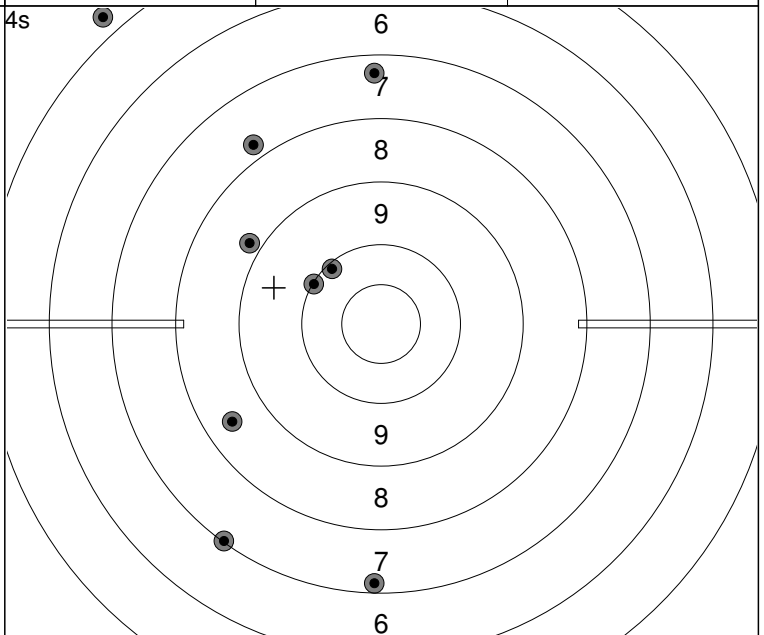
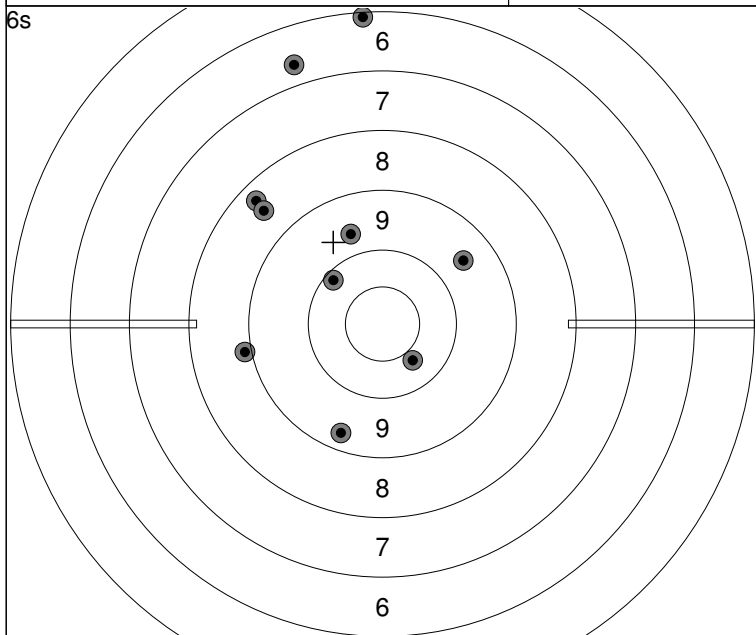

5: 2.38s 10.4	↘
4: 3.21s 8.3	↗
3: 4.63s 6.7	↑
2: 5.22s 6.1	↑
1: 5.87s 9.5	↗

5: 1.81s 8.5	↗
4: 2.60s 10.1	↗
3: 3.46s 9.3	↓
2: 4.15s 8.9	←
1: 4.93s 9.7	↑

Series	83 (0x)
Series	172 (1x)

5: 1.62s 8.5	↙
4: 2.20s 7.8	↗
3: 2.69s 10.1	↗
2: 3.19s 0.0	↗
1: 3.82s 7.3	↑

5: 1.73s 7.2	↓
4: 2.32s 7.0	↘
3: 2.88s 8.8	↗
2: 3.42s	☒
1: 3.94s 10.0	↖

Series	64 (0x)
Series	236 (1x)

Relay 2	Lane 18	PADDA Davinderjit (dave)
-------------------	-------------------	---------------------------------

2023 SFC Pistol Nationals	BC	EX	MP
---------------------------	----	----	----

14.07.2023	23PNRF2S1	Alberta Handgun Association
------------	-----------	-----------------------------

Comment	Signature
---------	-----------

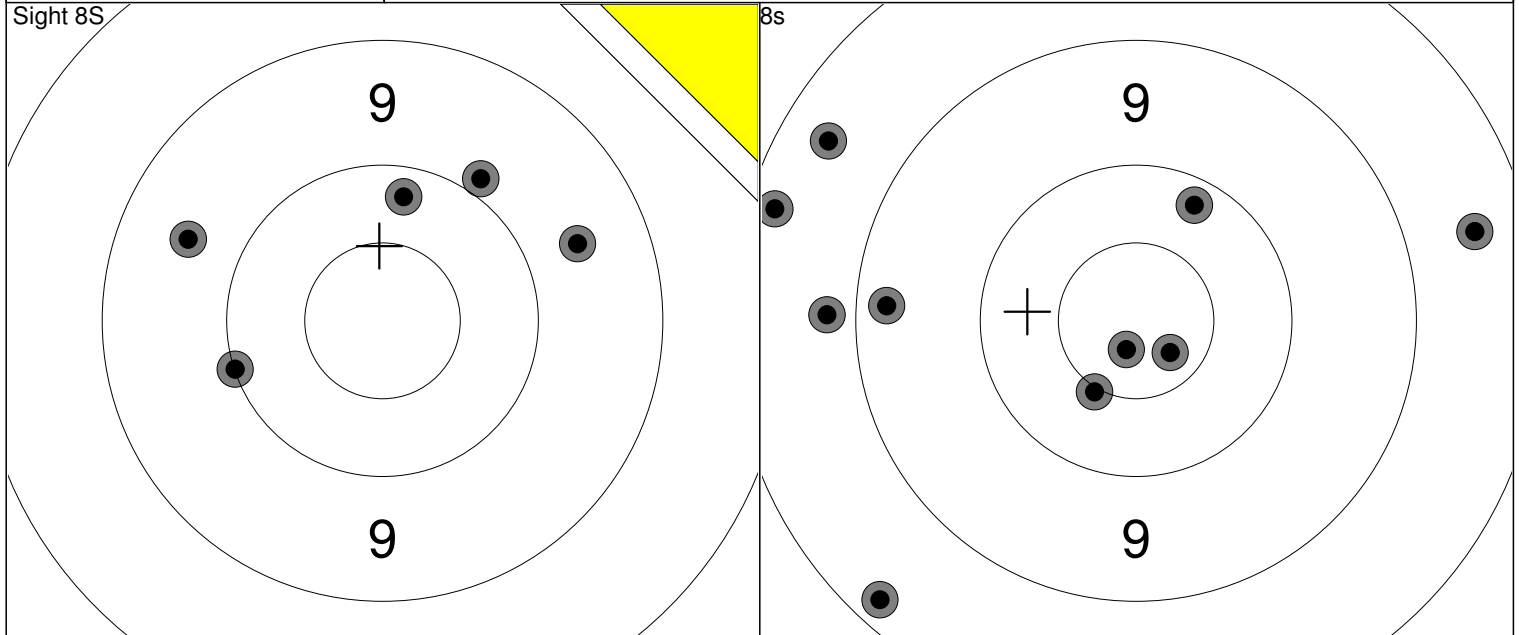

1: 2.17s 9.6 ↖	2: --		1: 2.55s 8.5 →	1: 2.42s 8.8 ←	
2: 3.11s 10.2 ↑		Series	2: 3.62s 8.4 ↖	2: 3.46s 8.2 ←	Series
3: 4.02s 9.9 ↗		47 (0x)	3: 4.55s 10.5x ↘	3: 4.49s 9.3 ←	
4: 4.94s 9.6 →		0 (0x)	4: 5.39s 10.8x ↘	4: 5.59s 8.2 ↘	89 (3x)
5: 5.94s 10.0 ←			5: 6.39s 10.7x ↘	5: 6.85s 10.2 ↗	

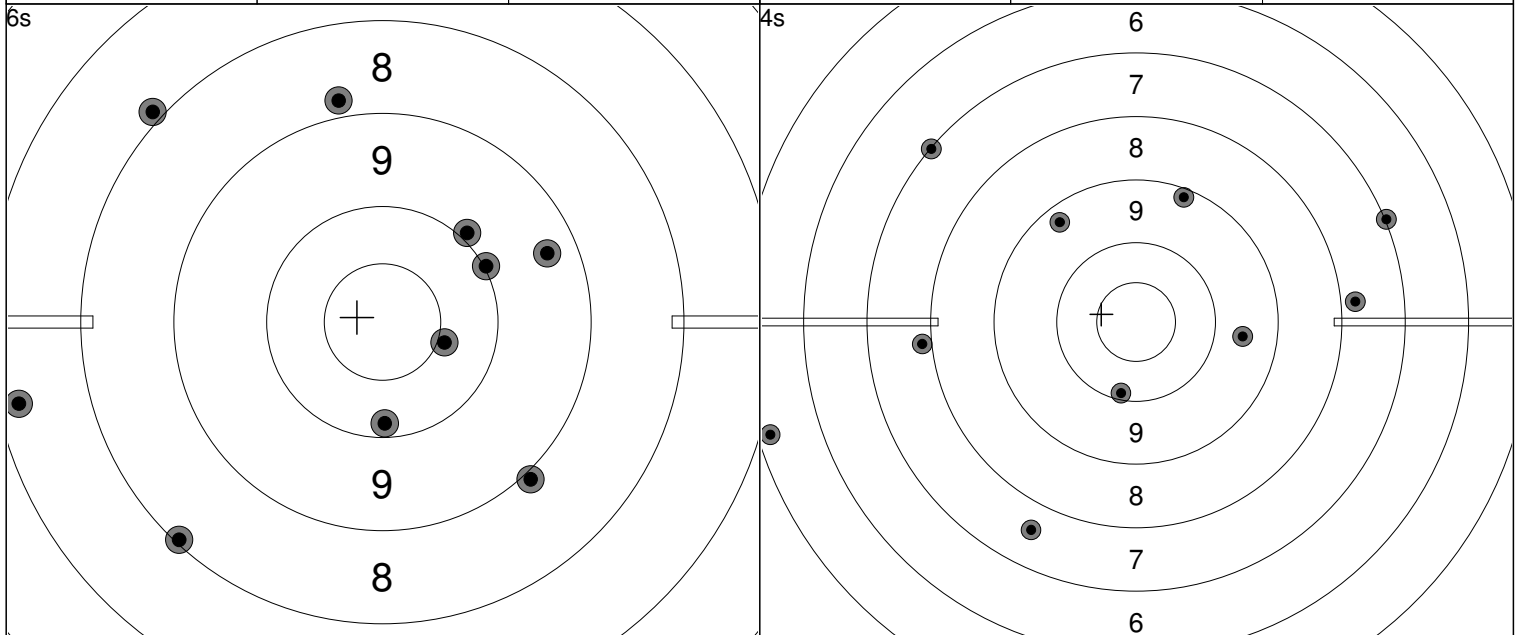

1: 1.93s 9.3 →	1: 2.20s 9.9 ↗		1: 1.60s 7.0 →	1: 1.80s 7.0 ↖	
2: 2.77s 7.9 ↖	2: 3.07s 8.8 ↑	Series	2: 2.33s 7.9 ←	2: 2.42s 5.2 ←	Series
3: 3.63s 10.4 →	3: 3.96s 8.1 ↘	86 (0x)	3: 2.92s 9.6 →	3: 3.05s 7.8 →	
4: 4.49s 10.0 →	4: 4.90s 10.1 ↓	175 (3x)	4: 3.49s 10.1 ↘	4: 3.61s 9.2 ↗	77 (0x)
5: 5.37s 8.9 ↘	5: 5.85s 7.3 ←		5: 4.04s 9.3 ↖	5: 4.15s 7.6 ↘	252 (3x)

Comment	Signature
---------	-----------

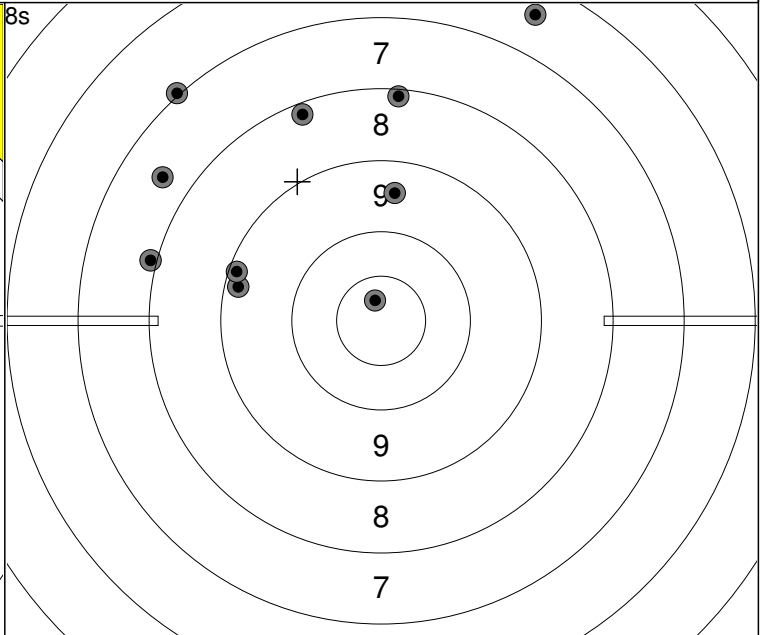
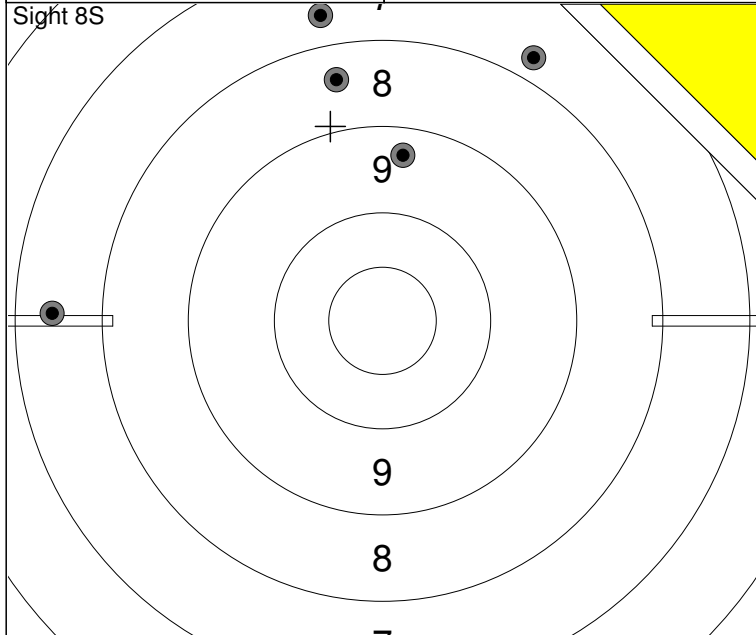

1: 2.44s	7.7	↑
2: 3.58s	9.3	↑
3: 4.63s	7.8	↗
4: 5.69s	8.4	↑
5: 6.89s	7.4	←

Series	38 (0x)
	0 (0x)

1: 2.62s	10.7x	↑
2: 3.82s	7.0	↗
3: 5.13s	8.2	↑
4: 6.18s	7.6	↗
5: 7.32s	7.9	←

1: 2.62s	9.5	↑
2: 3.79s	9.2	←
3: 5.02s	6.5	↗
4: 6.10s	9.1	←
5: 7.36s	8.1	↑

Series	80 (1x)
	80 (1x)

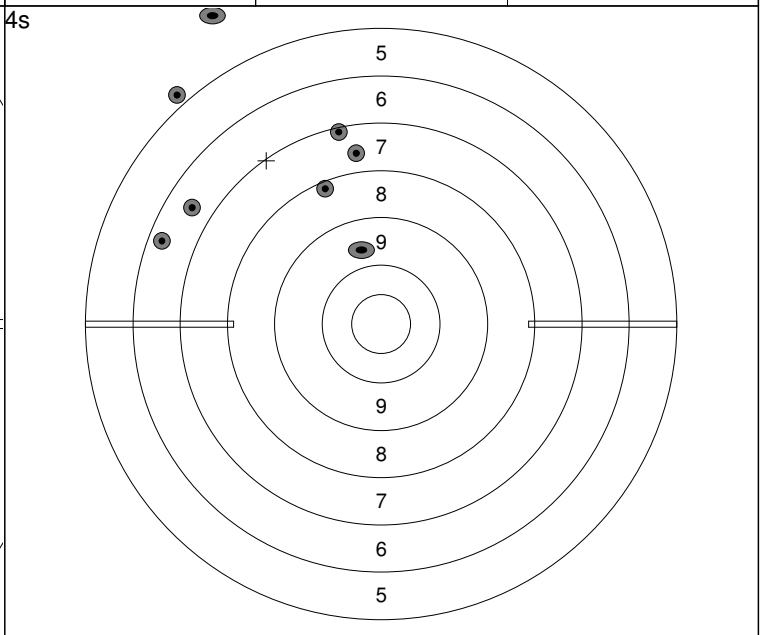
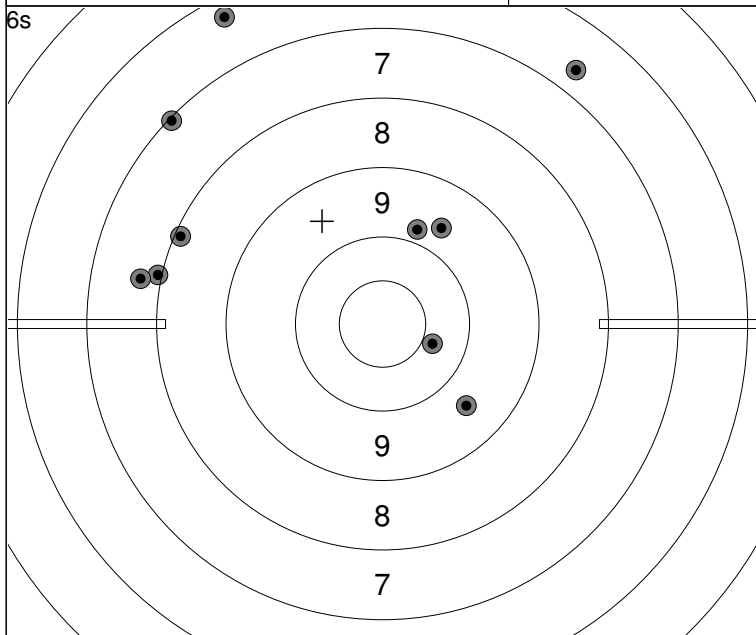

1: 1.96s	8.0	←
2: 3.09s	9.8	↑
3: 4.06s	10.4	↘
4: 5.01s	9.6	↗
5: 5.93s	8.1	←

1: 2.22s	7.0	↗
2: 3.29s	6.3	↗
3: 4.29s	9.6	↘
4: 5.15s	6.7	↗
5: 5.94s	7.7	←

Series	79 (0x)
	159 (1x)

1: 2.02s	6.6	←
2: 2.94s	7.1	↑
3: 3.74s	8.2	↗
4: 0.18s	7.4	↘
5:	--	

1: 1.96s	6.3	←
2: 2.77s	7.6	↑
3: 3.52s	0.0	↗
4: 0.05s	7.4	↘
5:	--	

Series	34 (0x)
	193 (1x)

Relay 3	Lane 3	MARKEWICZ Alan
-------------------	------------------	-----------------------

2023 SFC Pistol Nationals	AB	EX	MP
---------------------------	----	----	----

14.07.2023	23PNRF2S1	Alberta Handgun Association
------------	-----------	-----------------------------

Comment	Signature
---------	-----------

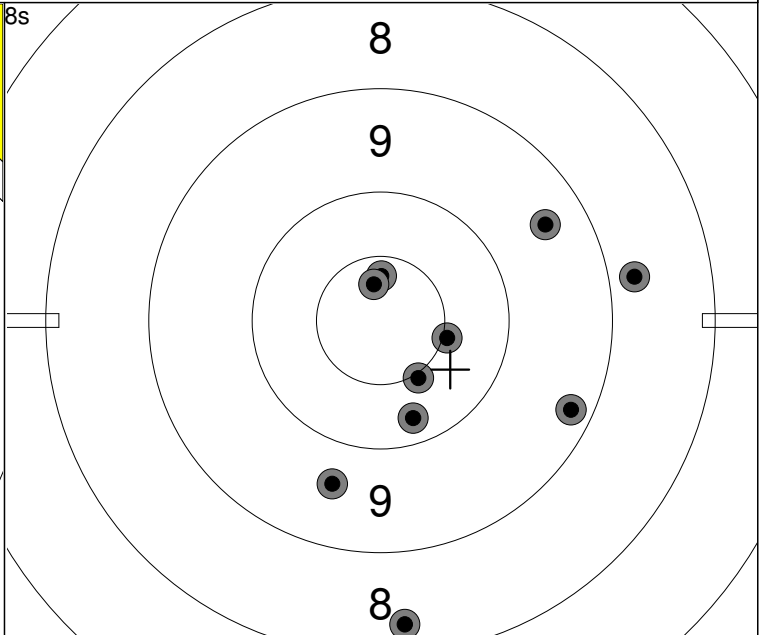
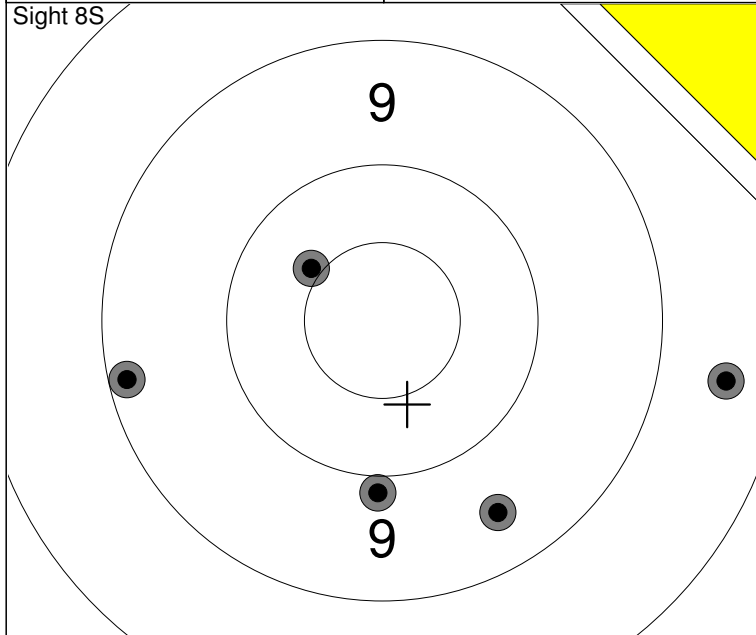

1: 2.64s	10.4	↗
2: 3.68s	9.9	↓
3: 4.82s	9.2	←
4: 6.39s	9.5	↙
5: 8.01s	8.5	→

Series	45 (0x)
	0 (0x)

1: 2.42s	10.4x	→
2: 3.56s	10.4x	↘
3: 4.68s	8.3	↓
4: 5.83s	9.2	↘
5: 7.21s	10.2	↘

1: 2.39s	10.6x	↑
2: 3.40s	9.6	↓
3: 4.39s	10.7x	↑
4: 5.51s	8.8	→
5: 6.47s	9.4	↗

Series	93 (4x)
	93 (4x)

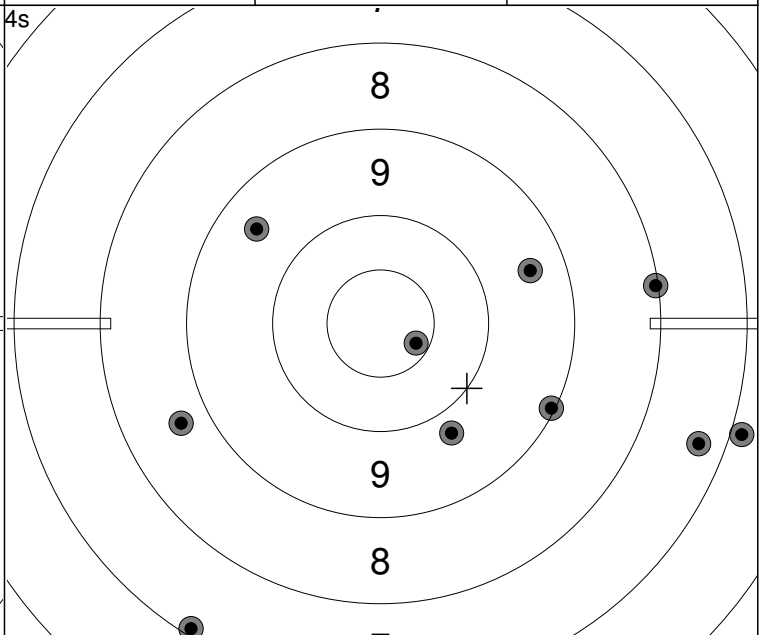
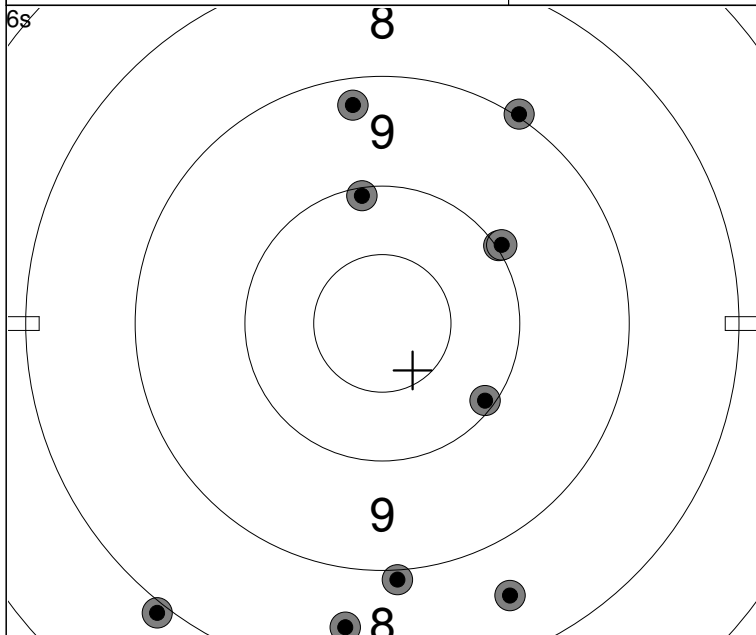

1: 2.28s	10.1	↘
2: 3.09s	8.5	↓
3: 3.97s	10.1	↑
4: 4.77s	8.9	↓
5: 5.63s	8.5	↓

1: 2.13s	10.0	↗
2: 3.01s	9.0	↗
3: 3.89s	9.3	↑
4: 4.83s	7.9	↙
5: 5.70s	10.0	↗

Series	89 (0x)
	182 (4x)

1: 1.64s	8.1	→
2: 2.29s	6.9	→
3: 2.84s	8.7	←
4: 3.34s	7.3	↘
5: 3.97s	7.1	↙

1: 1.88s	10.6x	↘
2: 2.44s	9.8	↓
3: 3.02s	9.1	↘
4: 3.52s	9.4	→
5: 4.04s	9.5	↖

Series	82 (1x)
	264 (5x)

Relay 3	Lane 8	AASA Toomas
-------------------	------------------	--------------------

2023 SFC Pistol Nationals	ON	MA	MP
---------------------------	----	----	----

14.07.2023	23PNRF2S1	Alberta Handgun Association
------------	-----------	-----------------------------

Comment	Signature
---------	-----------

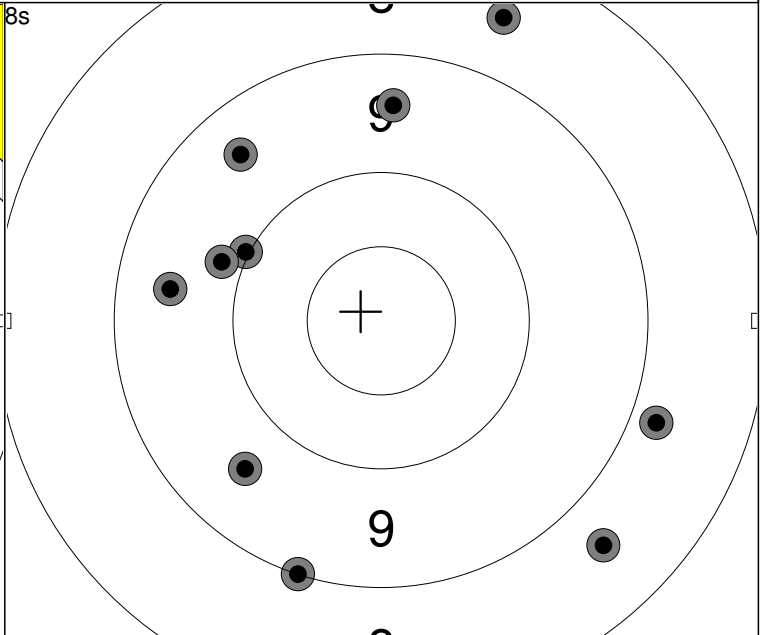
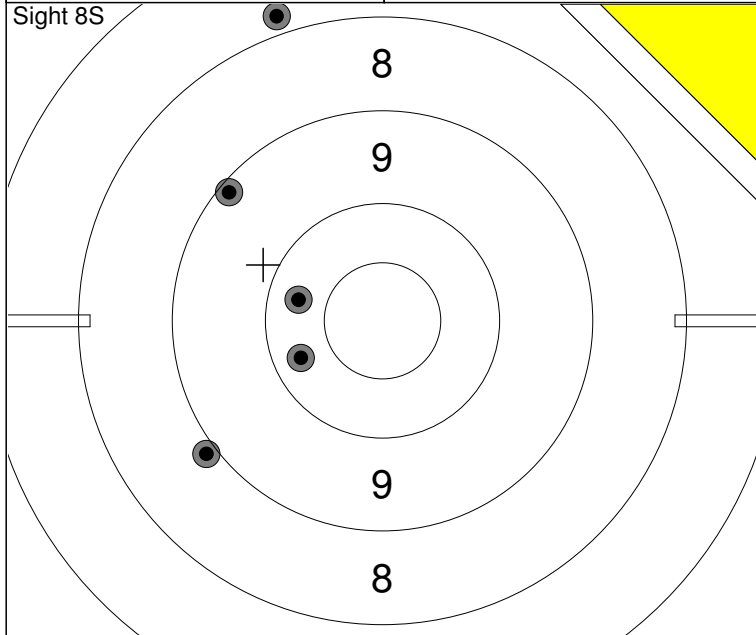

1: 2.13s	7.8	↗
2: 3.17s	10.2	↖
3: 4.18s	9.1	↗
4: 5.21s	8.9	↖
5: 6.31s	10.2	↖

Series	44 (0x)
	0 (0x)

1: 2.29s	9.5	↑
2: 3.26s	9.6	↘
3: 4.21s	8.5	↗
4: 5.15s	8.8	↘
5: 6.39s	9.4	↗

1: 1.92s	10.0	↖
2: 3.04s	9.5	↖
3: 4.24s	9.8	↖
4: 5.44s	9.0	↘
5: 6.54s	8.6	↘

Series	88 (0x)
	88 (0x)

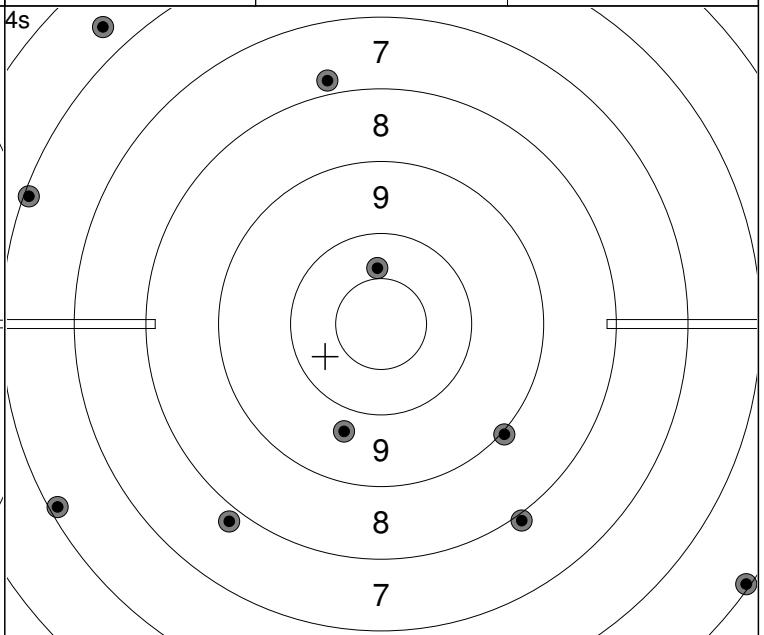
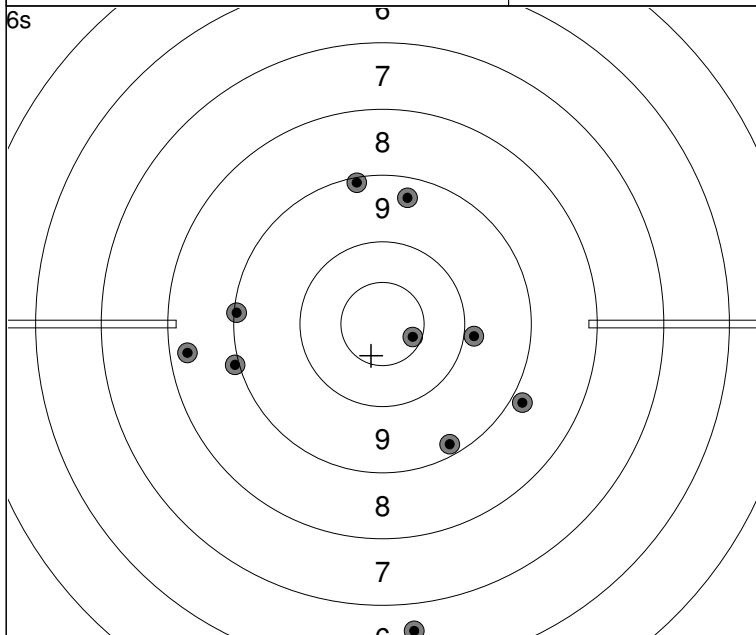

1: 1.68s	8.8	↘
2: 2.43s	9.1	↗
3: 3.17s	9.2	↘
4: 3.88s	10.6x	↘
5: 4.57s	9.0	↖

1: 1.83s	9.3	↗
2: 2.96s	6.6	↘
3: 3.93s	8.3	↖
4: 4.60s	9.1	↖
5: 5.37s	9.9	↗

Series	86 (1x)
	174 (1x)

1: 1.41s	9.0	↘
2: 2.22s	5.1	↘
3: 2.81s	9.7	↘
4: 3.41s	6.1	↖
5: 4.04s	7.8	↘

1: 1.61s	5.6	↗
2: 2.15s	7.9	↘
3: 2.66s	10.4	↗
4: 3.11s	6.1	↖
5: 3.59s	7.8	↗

Series	71 (0x)
	245 (1x)

Relay 3	Lane 13	PYLE Thomas
-------------------	-------------------	--------------------

2023 SFC Pistol Nationals	BC	MA	MP
---------------------------	----	----	----

14.07.2023	23PNRF2S1	Alberta Handgun Association
------------	-----------	-----------------------------

Comment	Signature
---------	-----------

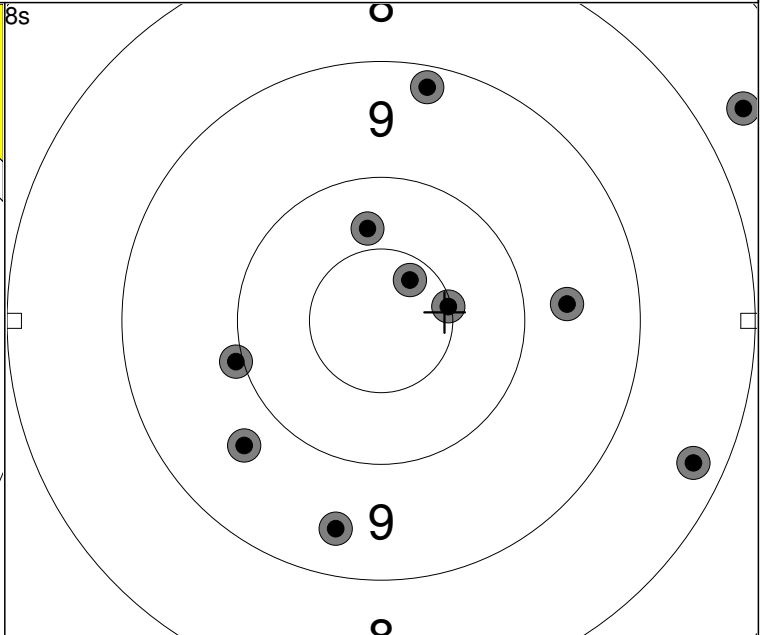
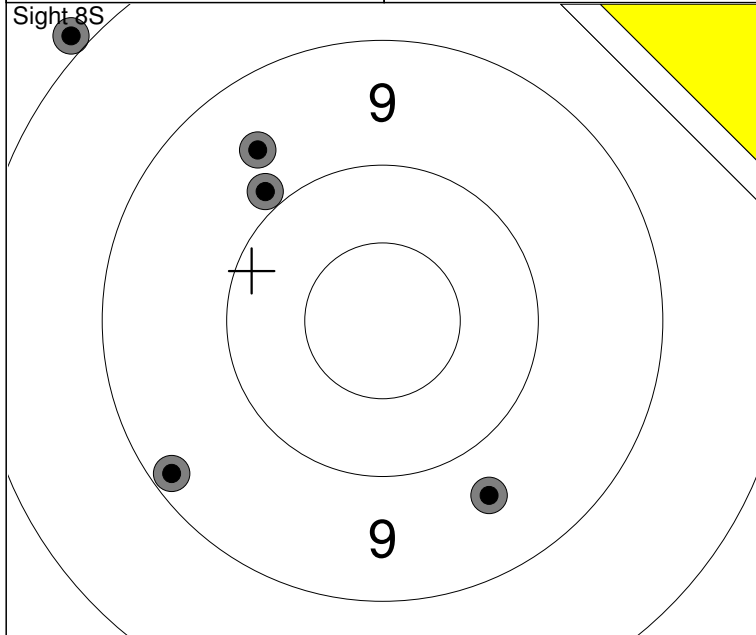

1: 1.91s	9.6	↘
2: 3.09s	7.9	↗
3: 4.05s	9.2	↙
4: 4.95s	9.6	↗
5: 6.32s	9.9	↗

Series	43 (0x)
	0 (0x)

1: 1.88s	9.2	↗
2: 2.83s	8.3	↘
3: 3.77s	9.6	→
4: 4.77s	10.5x	→
5: 5.68s	7.6	↘

1: 2.26s	9.4	↘
2: 3.19s	10.0	←
3: 4.12s	9.7	↙
4: 5.02s	10.6x	↗
5: 5.93s	10.3	↗

Series	91 (2x)
	91 (2x)

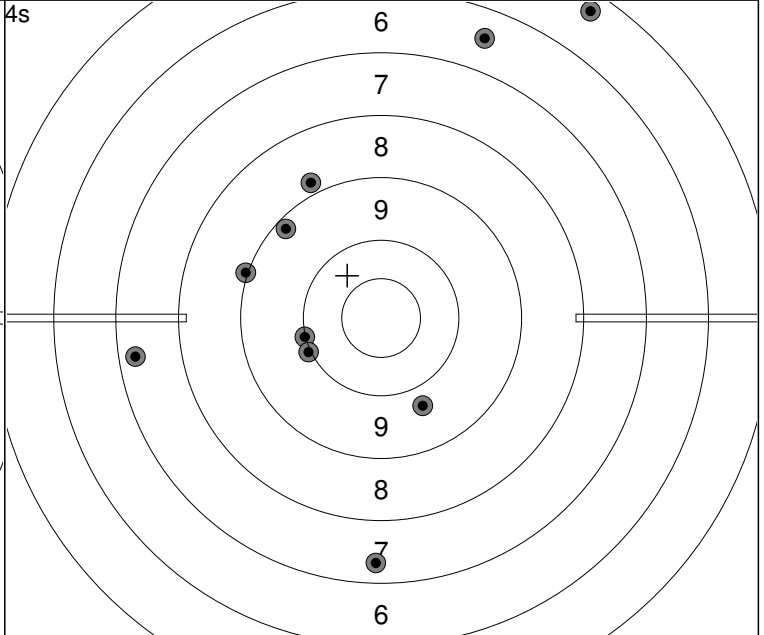
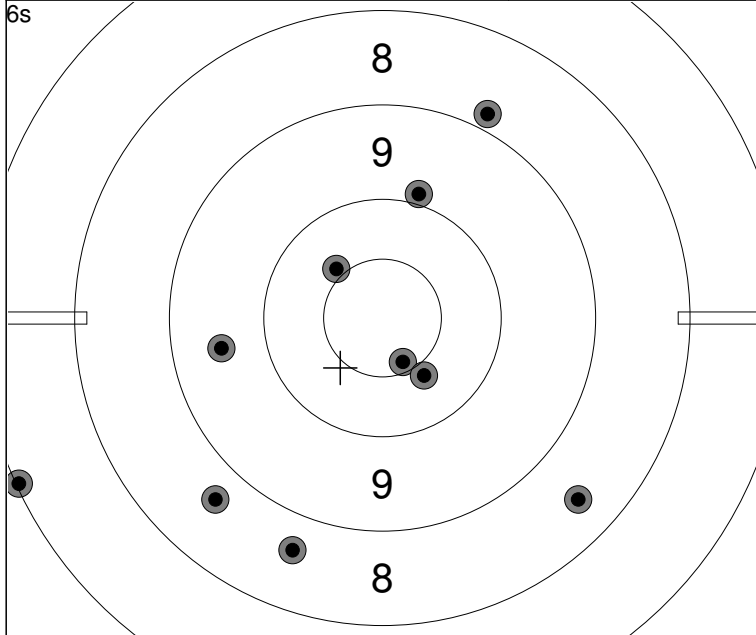

1: 1.78s	9.9	↗
2: 2.44s	8.4	↘
3: 3.03s	7.1	←
4: 3.67s	8.6	↘
5: 4.30s	10.6x	↘

Series	87 (1x)
	178 (3x)

1: 1.51s	5.3	↗
2: 1.98s	6.5	↗
3: 2.55s	8.8	↖
4: 3.13s	7.3	↘
5: 3.76s	10.0	←

1: 1.58s	9.7	↘
2: 2.12s	10.0	←
3: 2.69s	9.0	←
4: 3.16s	9.2	↗
5: 3.68s	7.3	←

Series	80 (0x)
	258 (3x)

Relay 3	Lane 18	OLSEN Jesse
-------------------	-------------------	--------------------

2023 SFC Pistol Nationals	SK	EX	MP
---------------------------	----	----	----

14.07.2023	23PNRF2S1	Alberta Handgun Association
------------	-----------	-----------------------------

Comment	Signature
---------	-----------

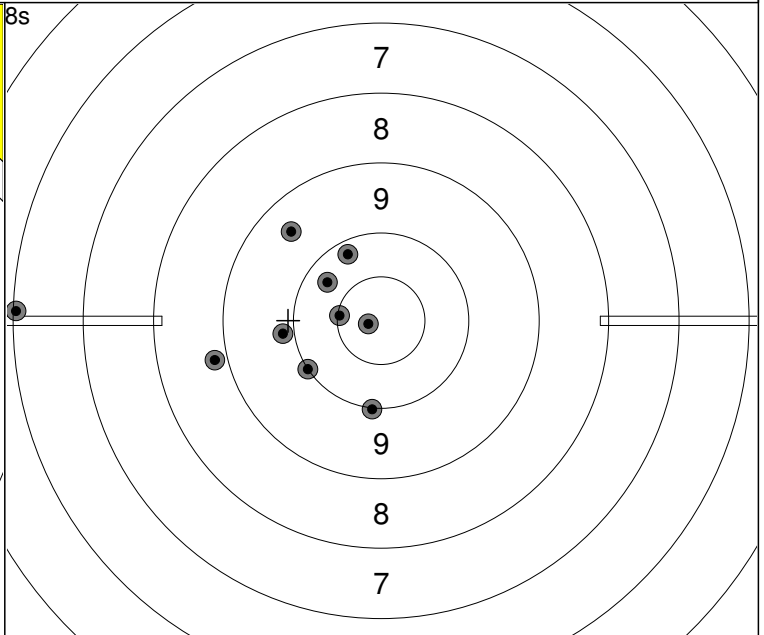
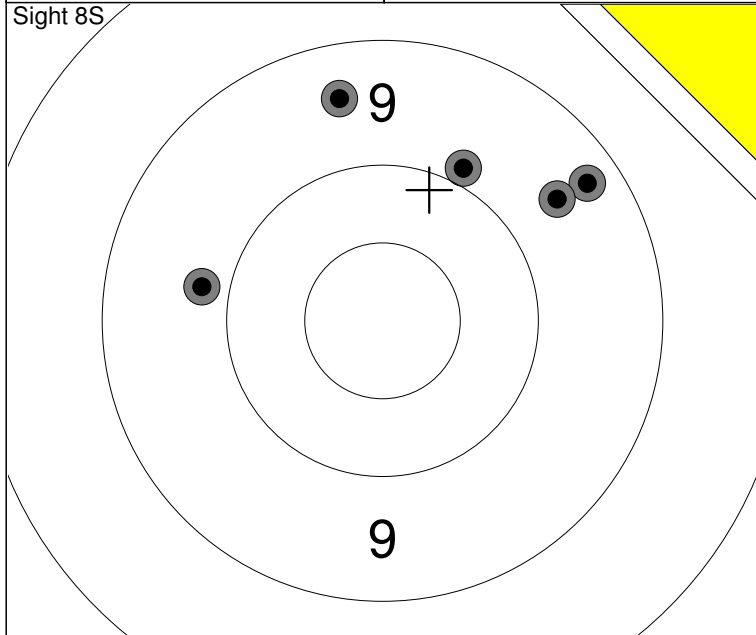

1: 2.07s 9.8 ←
2: 3.10s 9.3 ↗
3: 4.21s 9.9 ↗
4: 5.11s 9.6 ↗
5: 6.14s 9.5 ↑

Series	45 (0x)
Series	0 (0x)

1: 2.03s 10.0 ↙
2: 3.17s 10.1 ↗
3: 4.35s 9.5 ↗
4: 5.28s 10.2 ↗
5: 6.50s 10.8x ←

1: 2.18s 10.0 ↓
2: 3.12s 10.5x ←
3: 4.07s 9.9 ←
4: 5.14s 8.8 ←
5: 6.43s 6.1 ←

Series	92 (2x)
Series	92 (2x)

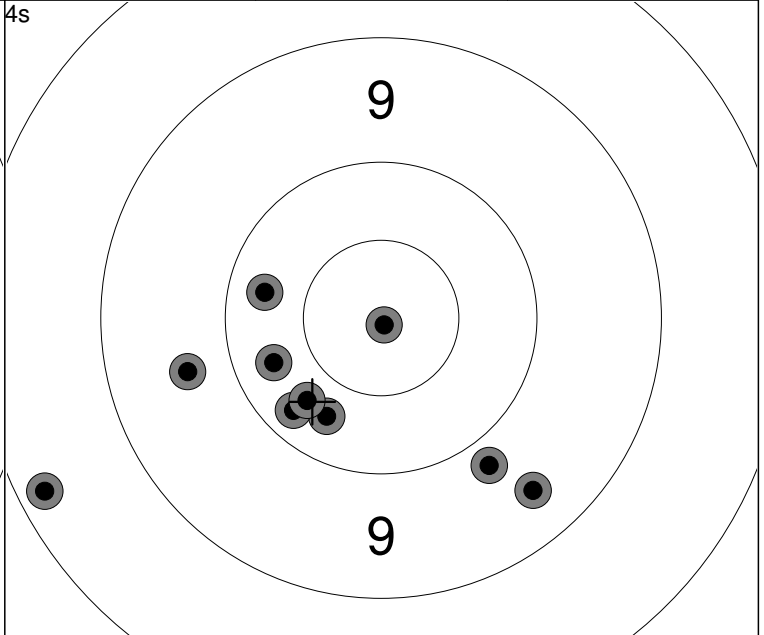
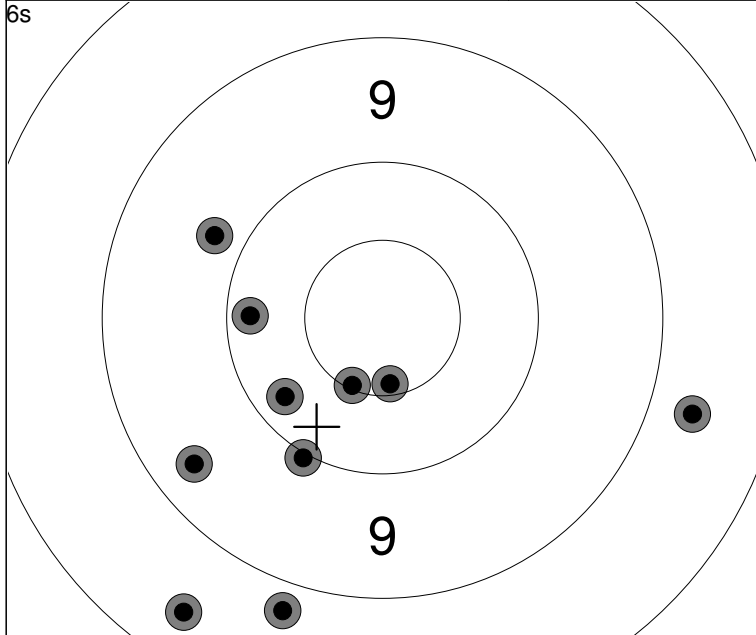

1: 2.25s 10.0 ↙
2: 2.91s 10.5x ↓
3: 3.62s 10.1 ←
4: 4.29s 9.8 ↙
5: 4.99s 10.5x ↓

1: 2.02s 10.2 ↙
2: 2.90s 9.4 ↙
3: 3.70s 8.7 →
4: 4.61s 8.4 ↙
5: 5.57s 8.8 ↓

Series	92 (2x)
Series	184 (4x)

1: 1.52s 10.3 ↙
2: 2.11s 10.2 ↙
3: 2.63s 10.9x ↓
4: 3.23s 9.4 ↙
5: 3.79s 8.2 ←

1: 1.60s 10.2 ←
2: 2.16s 9.8 ↓
3: 2.69s 10.3 ↙
4: 3.28s 10.2 ←
5: 3.91s 9.7 ←

Series	95 (1x)
Series	279 (5x)

Relay 3	Lane 23	WICK Werner
-------------------	-------------------	--------------------

2023 SFC Pistol Nationals	AB	MA	MP
---------------------------	----	----	----

14.07.2023	23PNRF2S1	Alberta Handgun Association
------------	-----------	-----------------------------

Comment	Signature
---------	-----------

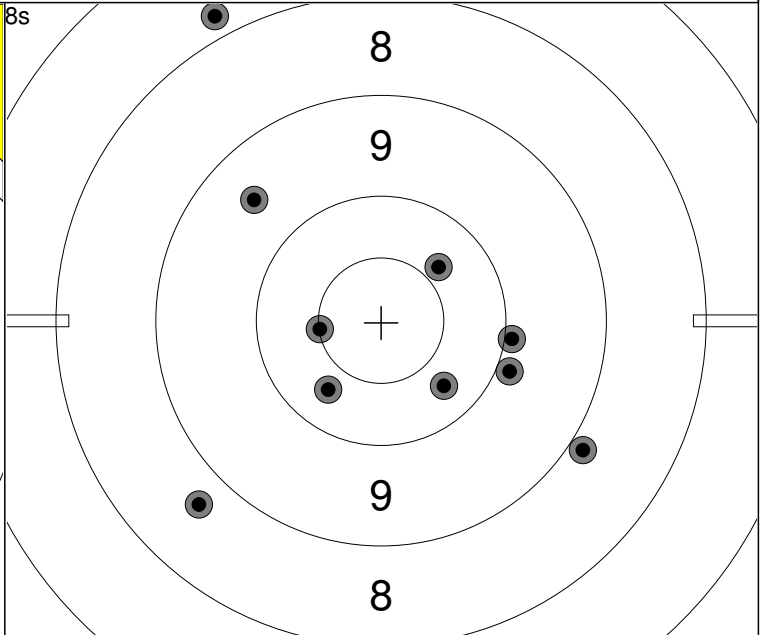
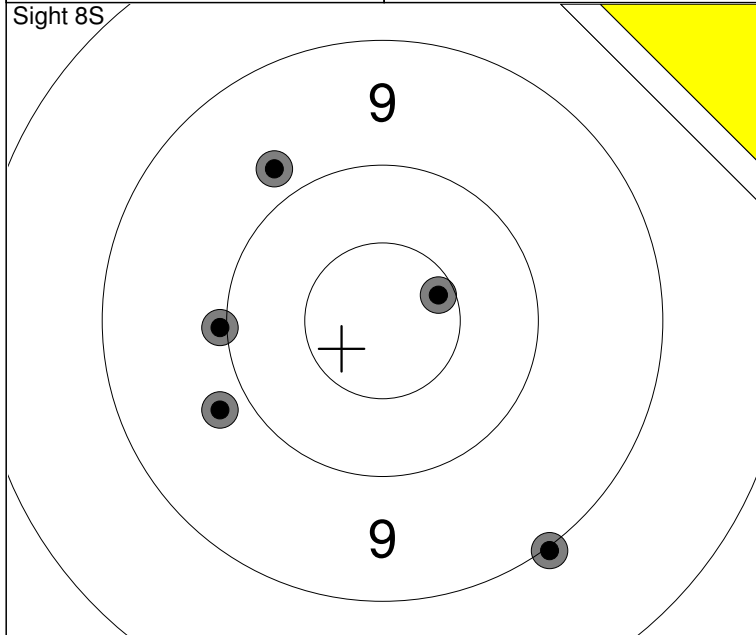

1: 2.05s 10.0 ←
2: 2.90s 9.8 ↙
3: 3.97s 9.0 ↘
4: 4.97s 9.8 ↗
5: 6.11s 10.6x →

Series	47 (1x)
Series	0 (0x)

1: 2.15s 7.8 ↗
2: 3.26s 10.4 ↗
3: 4.31s 10.0 →
4: 5.36s 10.5x ←
5: 6.14s 8.7 ↙

1: 2.19s 9.9 →
2: 3.20s 10.3 ↘
3: 4.25s 8.9 ↘
4: 5.09s 9.5 ↗
5: 5.96s 10.3 ↘

Series	91 (1x)
Series	91 (1x)

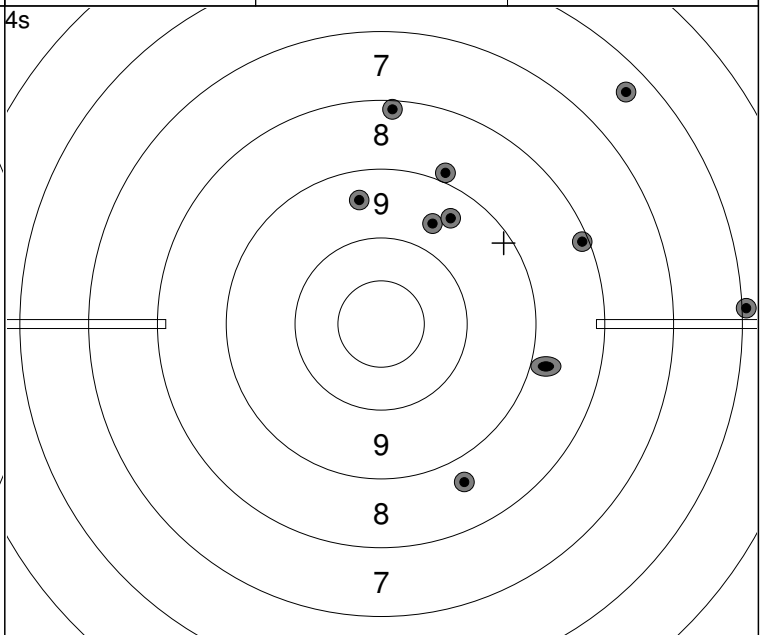
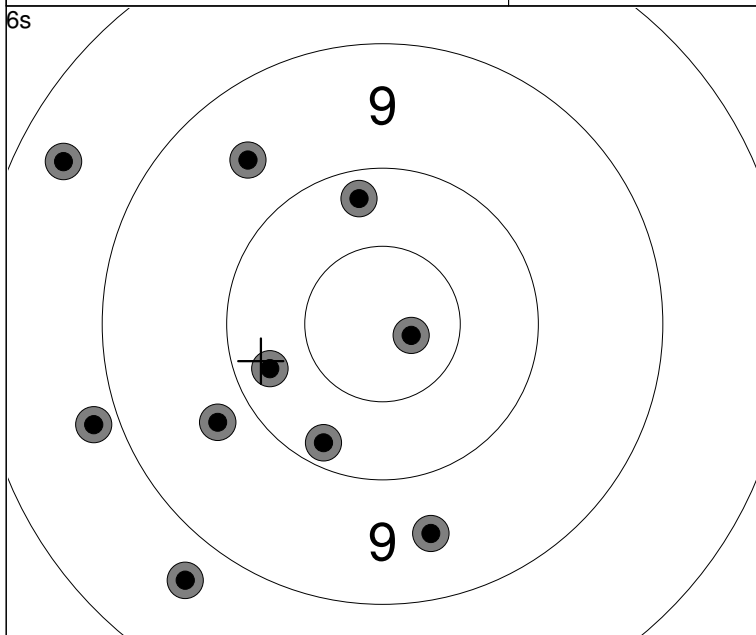

1: 2.06s 8.8 ←
2: 2.88s 10.2 ←
3: 3.62s 9.5 ↓
4: 4.34s 8.4 ↙
5: 5.14s 8.7 ↘

1: 2.00s 10.1 ↘
2: 3.05s 9.6 ↗
3: 3.77s 10.2 ↑
4: 4.49s 10.8x →
5: 5.39s 9.7 ←

Series	91 (1x)
Series	182 (2x)

1: 2.03s 9.6 ↗
2: 2.60s 8.1 →
3: 3.13s 6.4 ↗
4: 3.66s 9.4 ↑
5: 0.07s 7.4 ↘

1: 1.65s 8.7 ↘
2: 2.31s 8.9 ↗
3: 2.84s 6.0 →
4: 3.34s 8.1 ↑
5: 3.82s 9.4 ↗

Series	71 (0x)
Series	253 (2x)

Relay 1	Lane 18	NORMAN Seth
-------------------	-------------------	--------------------

2023 SFC Pistol Nationals SK	IJ	MP
------------------------------	----	----

14.07.2023	23PNRF2S2	Alberta Handgun Association
------------	-----------	-----------------------------

Comment	Signature
---------	-----------

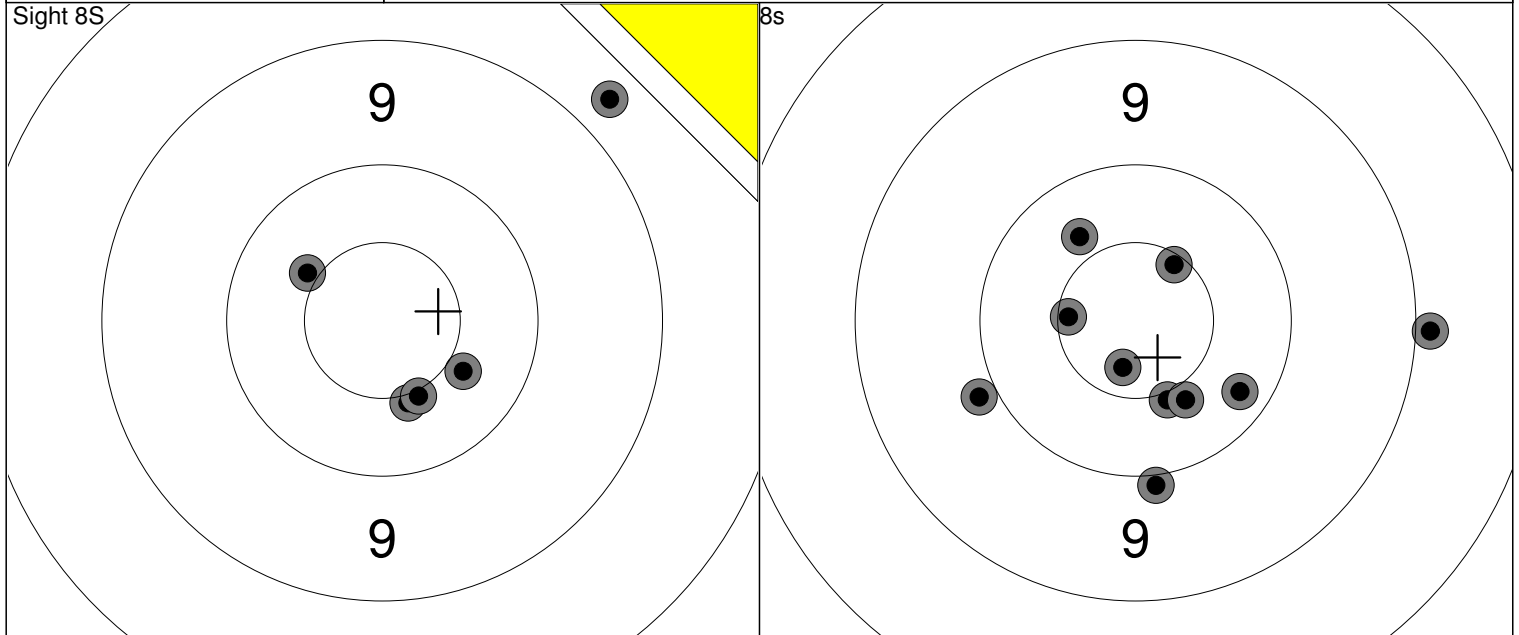

1: 2.35s 10.4x ↓ 2: 3.35s 8.7 ↗ 3: 4.44s 10.4 ↓ 4: 5.56s 10.4 ↗ 5: 6.59s 10.4x ↓	Series 48 (2x) 0 (0x)	1: 2.35s 9.9 ↓ 2: 3.50s 10.2 ↘ 3: 4.47s 8.9 → 4: 5.44s 10.4x ↓ 5: 6.36s 10.5x ↗	Series 96 (4x) 96 (4x)
--	--------------------------------	---	---------------------------------

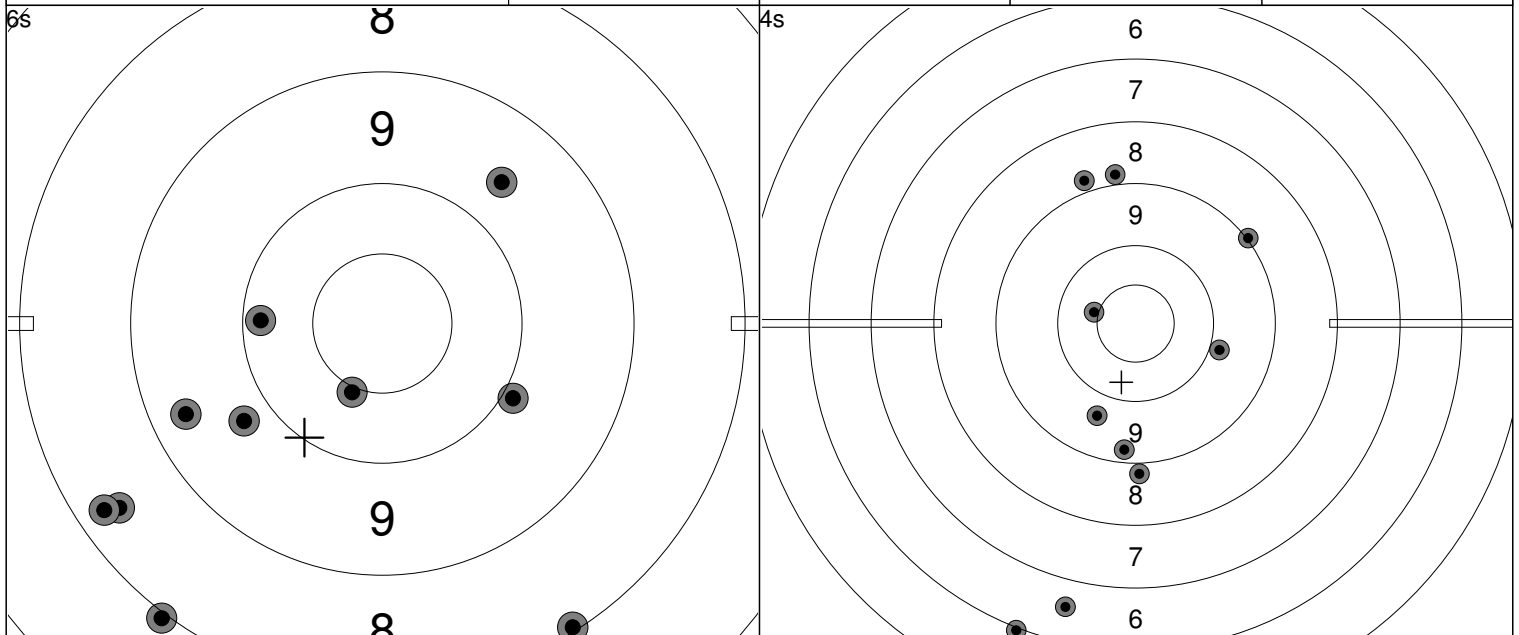

1: 2.05s 8.0 ↘ 2: 2.89s 10.1 ← 3: 3.78s 10.4x ↓ 4: 4.67s 8.4 ← 5: 5.41s 8.3 ←	1: 2.24s 9.6 ↗ 2: 3.15s 9.3 ← 3: 4.04s 9.8 ← 4: 4.81s 8.1 ↓ 5: 5.57s 9.9 ↘	Series 88 (1x) 184 (5x)	1: 1.69s 10.4x ← 2: 2.24s 9.7 ↓ 3: 2.77s 9.9 → 4: 3.28s 8.8 ↑ 5: 3.74s 6.6 ↓	Series 82 (1x) 266 (6x)
---	--	----------------------------------	--	----------------------------------

Relay 1	Lane 23	NORMAN Rex
-------------------	-------------------	-------------------

2023 SFC Pistol Nationals SK	JR	MP
------------------------------	----	----

14.07.2023	23PNRF2S2	Alberta Handgun Association
------------	-----------	-----------------------------

Comment	Signature
---------	-----------

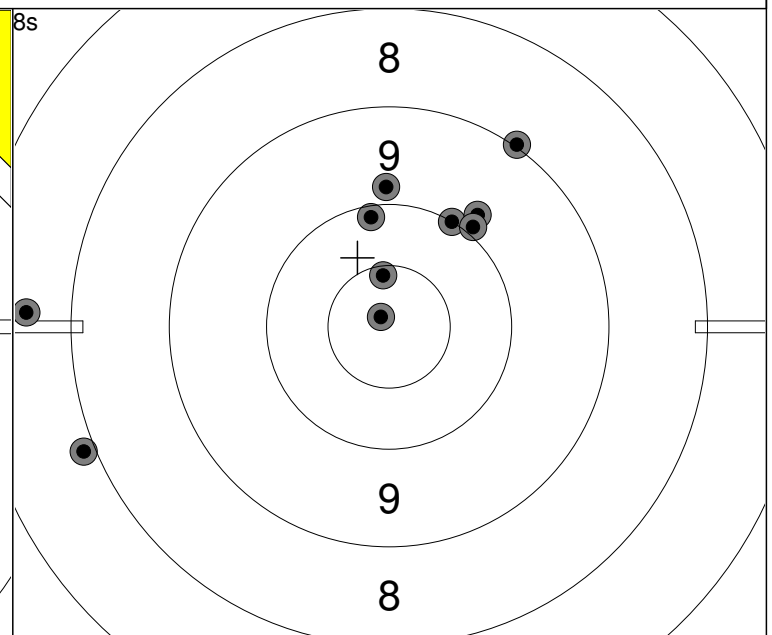
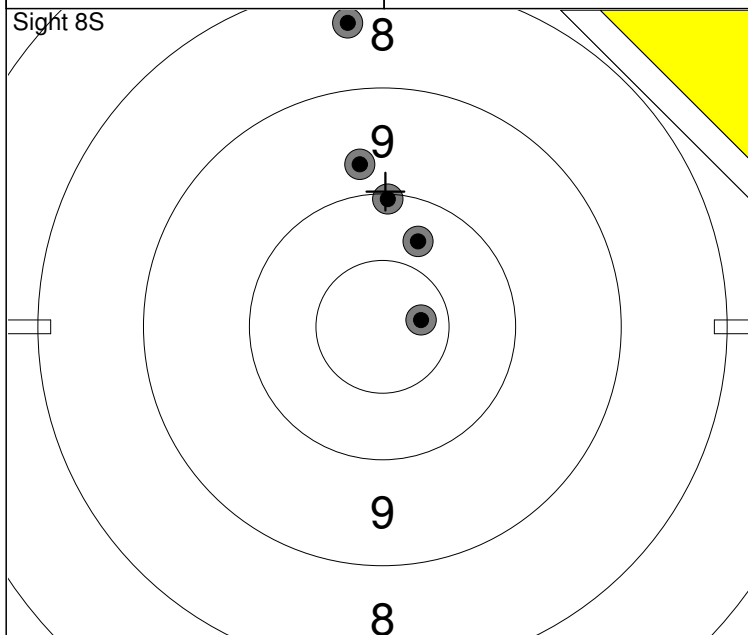

1: 2.69s	10.0	↑
2: 3.67s	8.4	↑
3: 4.85s	10.3	↗
4: 5.72s	9.7	↑
5: 6.55s	10.7x	→

Series	47 (1x)
	0 (0x)

1: 2.28s	9.0	↗
2: 3.42s	10.8x	↖
3: 4.52s	7.6	←
4: 5.31s	7.9	←
5: 6.49s	10.0	↗

1: 2.48s	10.1	↑
2: 3.47s	9.8	↗
3: 4.60s	9.9	↗
4: 6.01s	9.8	↑
5: 6.81s	10.5x	↑

Series	90 (2x)
	90 (2x)

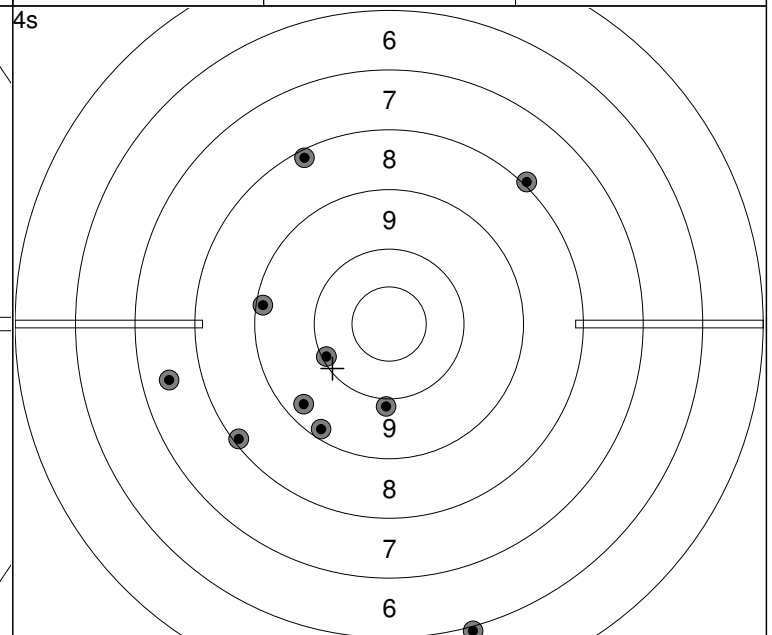
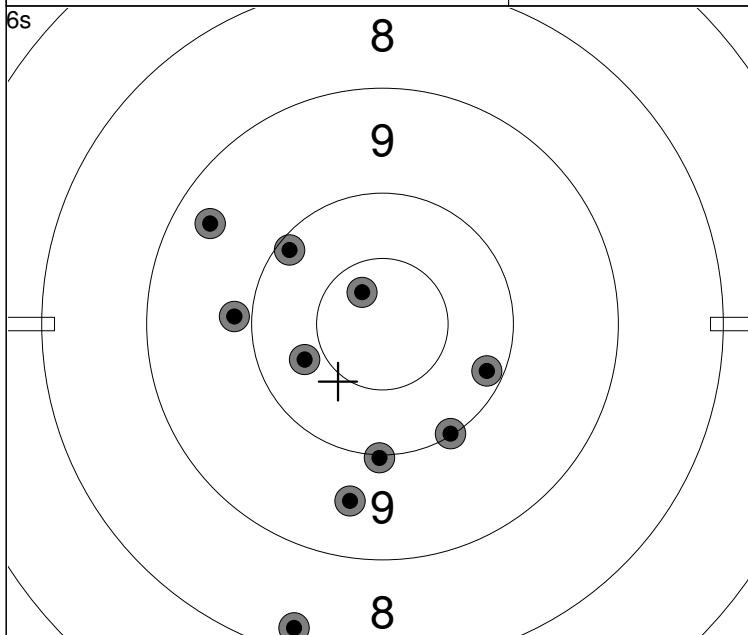

1: 1.94s	8.3	↓
2: 2.96s	10.1	→
3: 3.95s	10.1	↖
4: 4.61s	9.6	↓
5: 5.37s	10.0	↓

1: 2.39s	9.9	←
2: 3.23s	10.7x	↗
3: 3.97s	10.3	←
4: 4.75s	9.4	↗
5: 5.57s	10.0	↓

Series	95 (1x)
	185 (3x)

1: 1.58s	10.0	←
2: 2.19s	7.5	←
3: 2.81s	9.2	↓
4: 3.33s	8.1	←
5: 3.80s	9.1	←

1: 1.80s	9.9	↓
2: 2.42s	8.0	↗
3: 2.98s	9.3	↖
4: 3.50s	8.2	↗
5: 3.92s	5.9	↓

Series	82 (0x)
	267 (3x)

Relay 2	Lane 3	EK Nils
-------------------	------------------	----------------

2023 SFC Pistol Nationals	QC	EX	MP
---------------------------	----	----	----

14.07.2023	23PNRF2S2	Alberta Handgun Association
------------	-----------	-----------------------------

Comment	Signature
---------	-----------

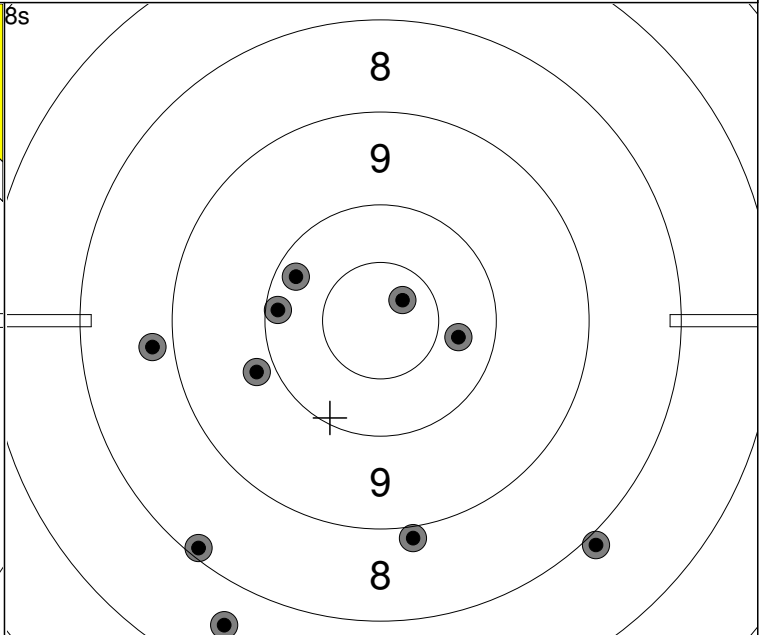
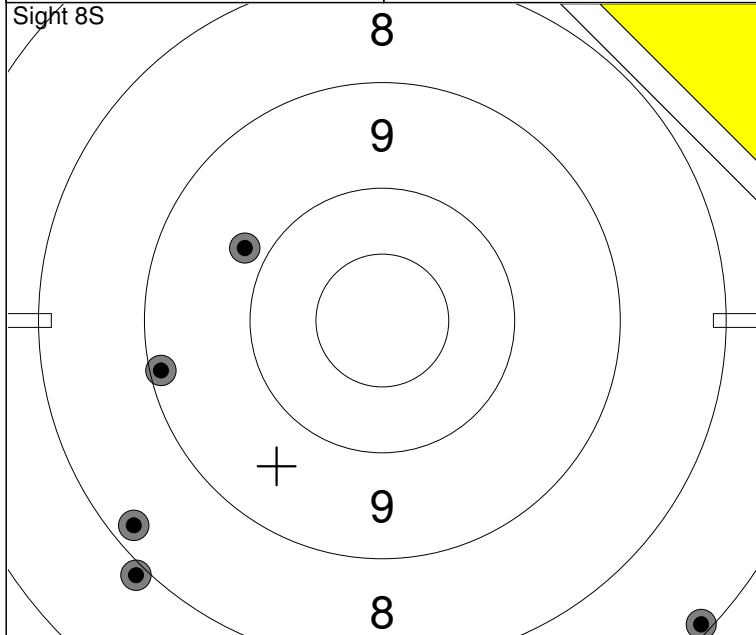

1: 2.82s	7.1	↘
2: 4.10s	8.2	↙
3: 5.31s	7.9	↙
4: 6.52s	9.8	↖
5: 7.76s	9.1	←

Series	40 (0x)
Series	0 (0x)

1: 2.47s	7.9	↘
2: 3.58s	8.1	↙
3: 4.74s	10.3	→
4: 5.95s	10.7x	↗
5: 7.21s	10.2	↖

1: 2.30s	8.9	↓
2: 3.52s	8.8	←
3: 4.80s	10.1	←
4: 6.17s	7.6	↘
5: 7.46s	9.8	←

Series	87 (1x)
Series	87 (1x)

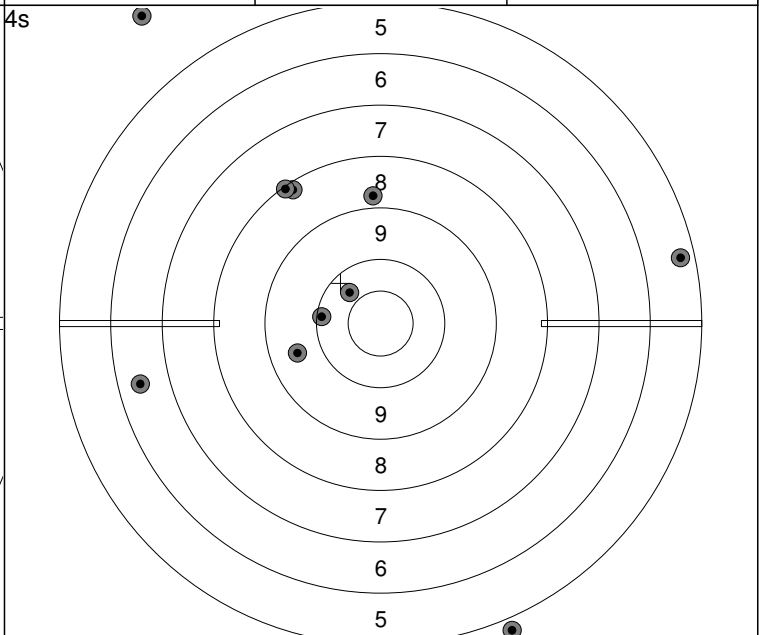
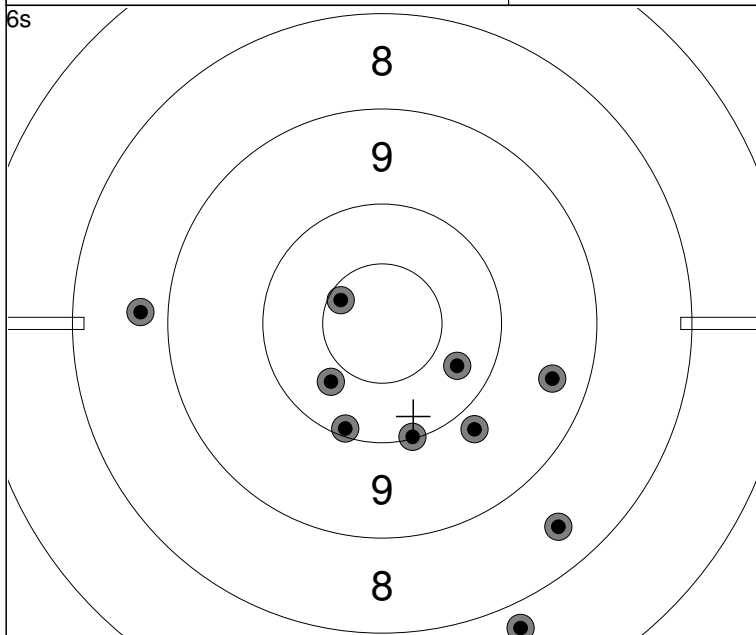

1: 2.33s	7.8	↘
2: 3.37s	9.8	↘
3: 4.29s	10.3	↙
4: 5.36s	9.4	→
5: 6.27s	10.0	↓

1: 2.19s	8.5	↘
2: 3.10s	10.1	↘
3: 3.94s	10.6x	↗
4: 4.76s	8.7	←
5: 5.51s	10.3	↘

Series	91 (1x)
Series	178 (2x)

1: 1.77s	8.8	↑
2: 2.21s	5.3	→
3: 2.70s	8.2	↗
4: 3.46s	8.1	↗
5: 3.91s	9.6	←

1: 1.47s	0.0	↓
2: 2.13s	10.3	↗
3: 2.77s	6.5	←
4: 3.36s	10.1	←
5: 4.20s	0.0	↗

Series	64 (0x)
Series	242 (2x)

Relay 2	Lane 8	KELLY Michael
-------------------	------------------	----------------------

2023 SFC Pistol Nationals	NS	EX	MP
---------------------------	----	----	----

14.07.2023	23PNRF2S2	Alberta Handgun Association
------------	-----------	-----------------------------

Comment	Signature
---------	-----------

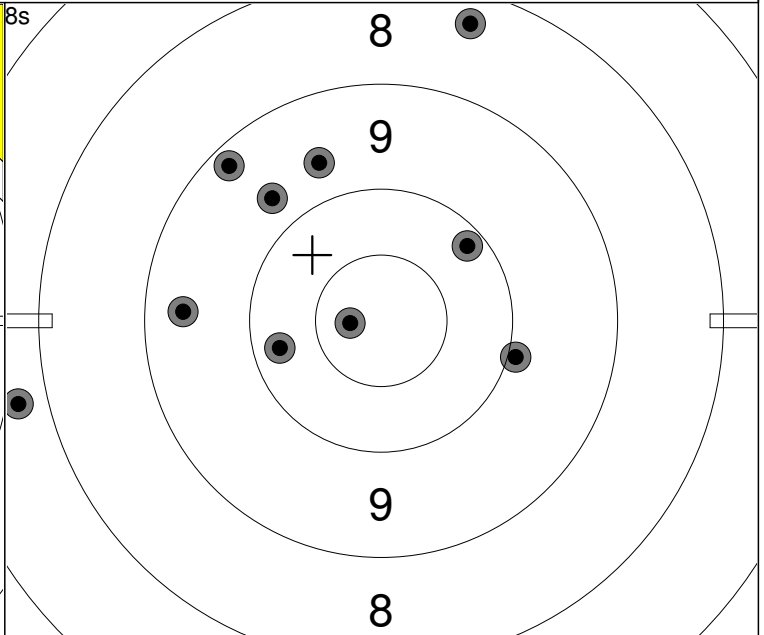
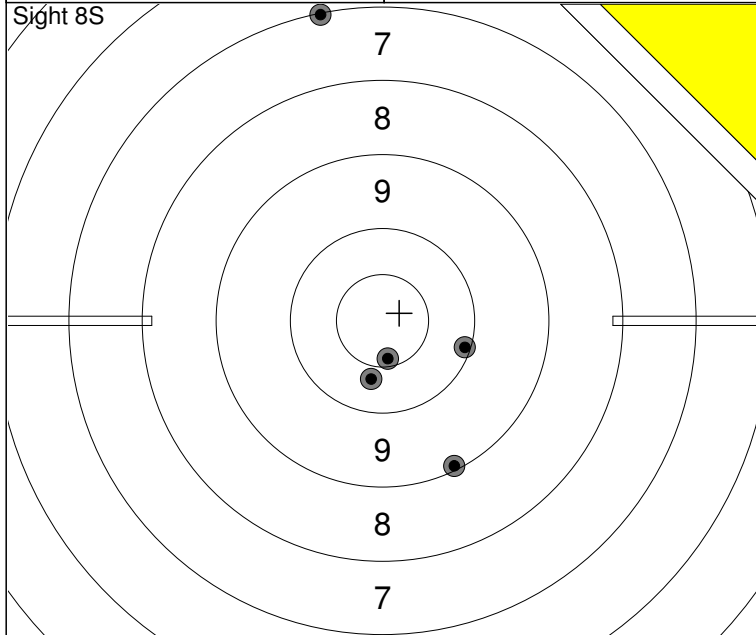

5: 2.09s	7.0	↑
4: 3.12s	10.1	→
3: 4.04s	10.6x	↓
2: 4.84s	9.1	↓
1: 5.77s	10.3	↓

Series	46 (1x)
Series	0 (0x)

5: 1.88s	8.3	↑
4: 2.81s	10.1	↗
3: 3.80s	7.7	←
2: 5.06s	9.7	↑
1: 6.45s	10.2	←

5: 1.89s	9.7	↗
4: 2.80s	9.2	↗
3: 3.97s	10.7x	←
2: 4.95s	9.4	←
1: 5.89s	9.9	→

Series	90 (1x)
Series	90 (1x)

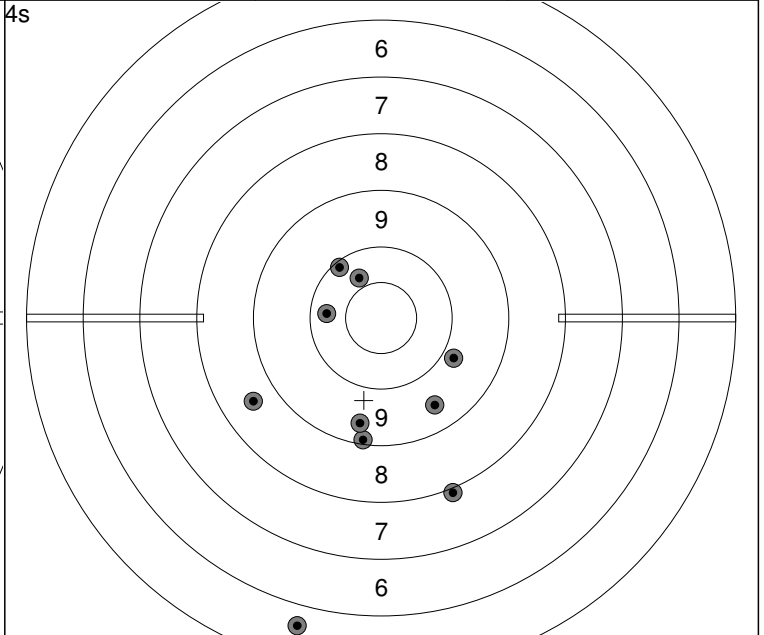
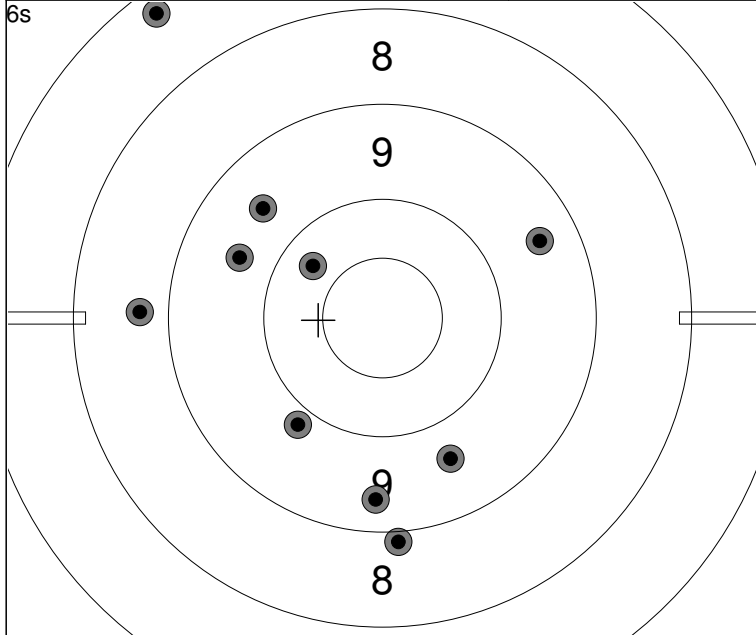

5: 1.84s	7.3	↗
4: 2.77s	9.4	↗
3: 3.52s	8.7	←
2: 4.29s	9.8	↘
1: 5.04s	10.3	↖

5: 2.09s	9.6	↗
4: 2.83s	9.4	↓
3: 3.52s	9.6	↖
2: 4.21s	8.9	↓
1: 4.90s	9.6	↘

Series	87 (0x)
Series	177 (1x)

5: 1.69s	10.2	←
4: 2.20s	5.7	↓
3: 2.84s	8.6	←
2: 3.32s	7.9	↓
1: 3.86s	9.1	↓

5: 1.75s	9.8	↘
4: 2.48s	10.1	↗
3: 3.10s	9.4	↓
2: 3.63s	10.3	↗
1: 4.25s	9.5	↘

Series	86 (0x)
Series	263 (1x)

Comment	Signature
---------	-----------

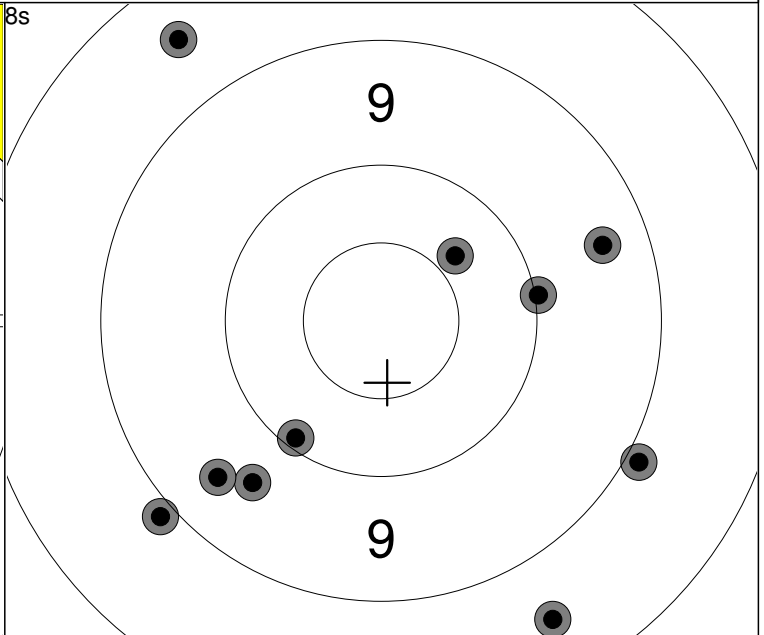
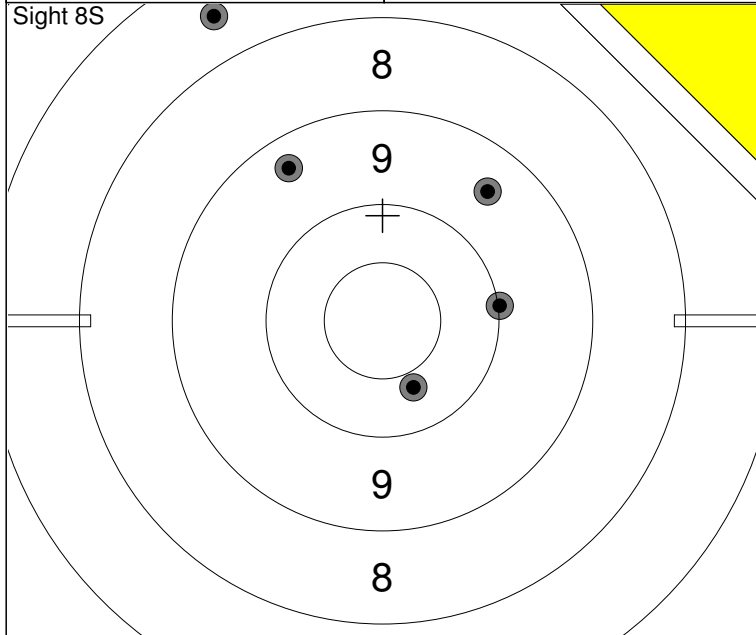

1: 2.51s 10.0 →
2: 3.78s 9.3 ↗
3: 5.04s 9.5 ↗
4: 6.10s 10.4 ↘
5: 7.21s 7.5 ↗

Series 45 (0x)
0 (0x)

1: 2.47s 8.5 ↖
2: 3.46s 9.6 ↘
3: 4.39s 9.5 ↘
4: 5.36s 10.1 ↘
5: 6.37s 9.4 →

1: 2.48s 10.0 →
2: 3.73s 8.9 ↘
3: 4.78s 8.9 ↘
4: 5.92s 10.3 ↗
5: 7.25s 8.5 ↘

Series 89 (0x)
89 (0x)

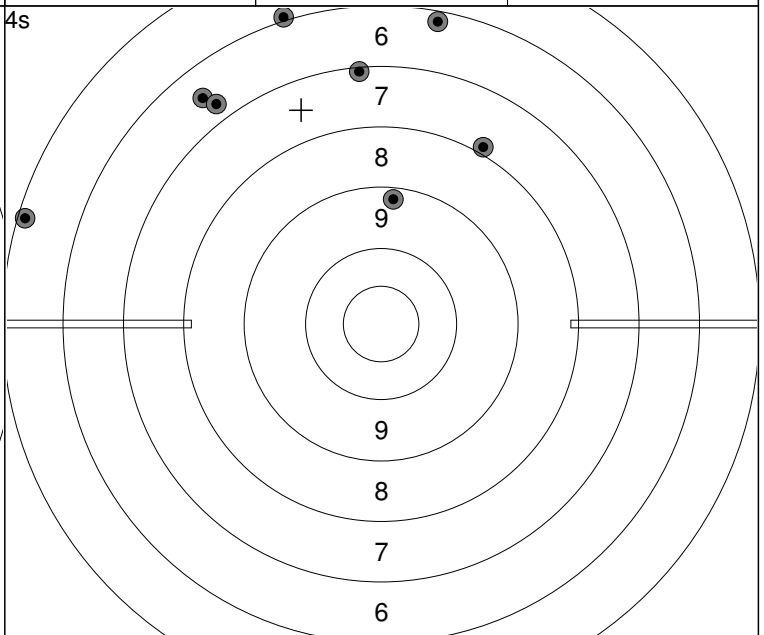
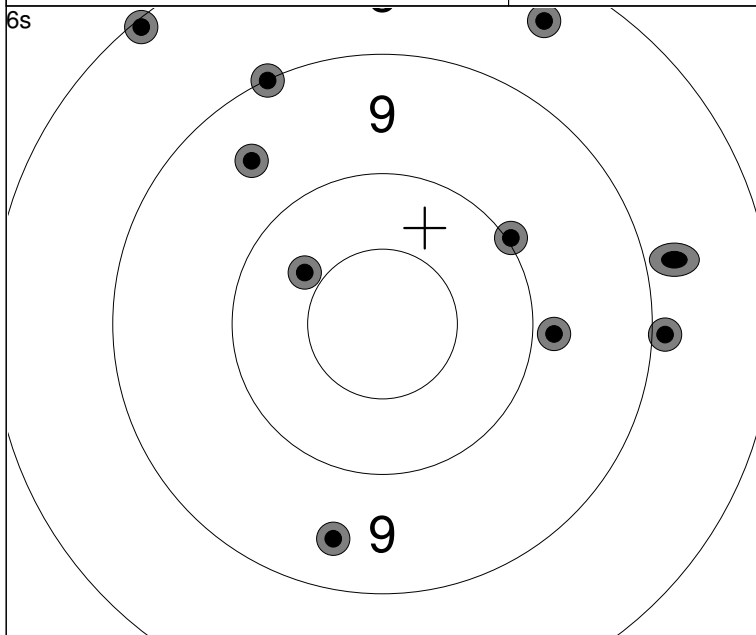

1: 2.25s 9.4 ↘
2: 3.41s 10.4 ↖
3: 4.36s 8.9 →
4: 5.27s 10.0 ↗
5: 0.03s ↖

1: 2.14s 8.1 ↗
2: 3.04s 9.8 →
3: 3.77s 9.5 ↗
4: 4.53s 9.0 ↗
5: 5.31s 8.4 ↗

Series 80 (0x)
169 (0x)

1: 1.88s 6.5 ↖
2: 2.57s 5.1 ←
3: 3.24s 7.9 ↗
4: 3.91s 6.0 ↗
5: 0.17s ↖

1: 1.73s 6.7 ↖
2: 2.55s 9.2 ↑
3: 3.24s 7.1 ↑
4: 3.94s 6.2 ↑
5: --

Series 52 (0x)
221 (0x)

Relay 2	Lane 18	SANDALL Jim
-------------------	-------------------	--------------------

2023 SFC Pistol Nationals	MB	EX	MP
---------------------------	----	----	----

14.07.2023	23PNRF2S2	Alberta Handgun Association
------------	-----------	-----------------------------

Comment	Signature
---------	-----------

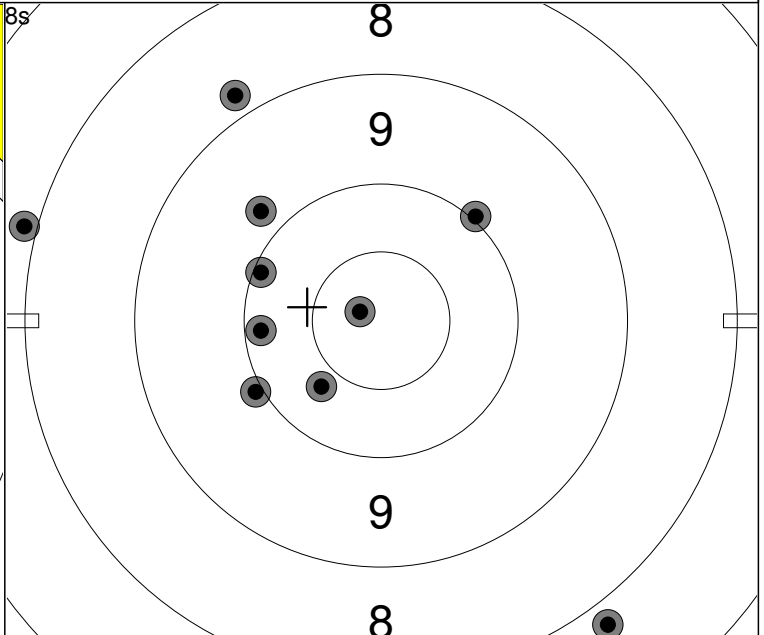
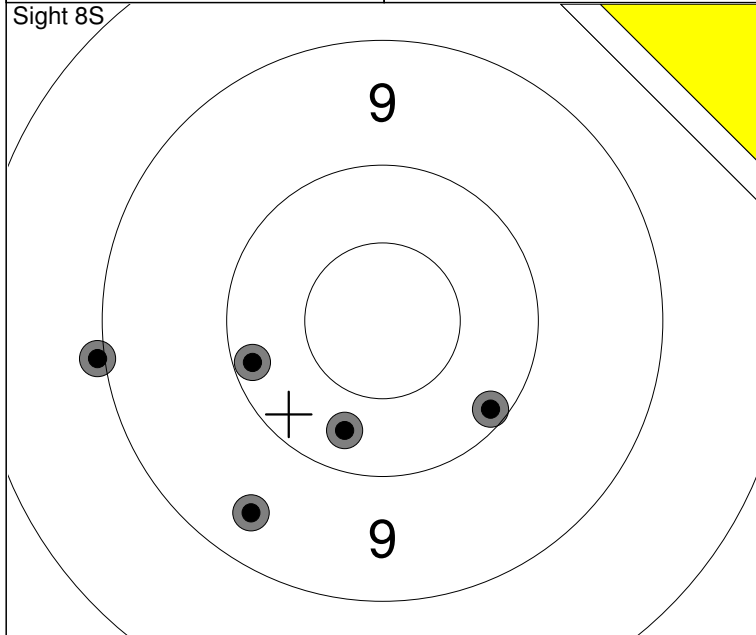

1: 2.67s 10.1 ↘
2: 3.65s 10.2 ↓
3: 4.64s 9.4 ↘
4: 5.68s 9.0 ←
5: 6.61s 10.1 ←

Series	48 (0x)
	0 (0x)

1: 2.72s 10.1 ←
2: 3.61s 10.3 ↘
3: 4.94s 9.8 ↗
4: 5.54s 7.9 ←
5: 6.47s 10.0 ←

1: 2.64s 7.8 ↘
2: 3.65s 10.1 ←
3: 4.53s 10.8x ↘
4: 5.38s 8.8 ↗
5: 6.47s 10.0 ↗

Series	91 (1x)
	91 (1x)

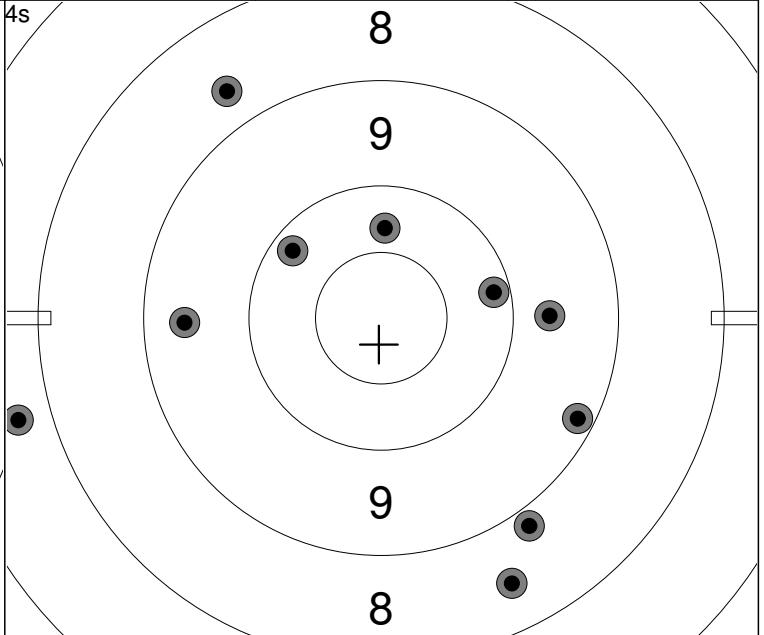
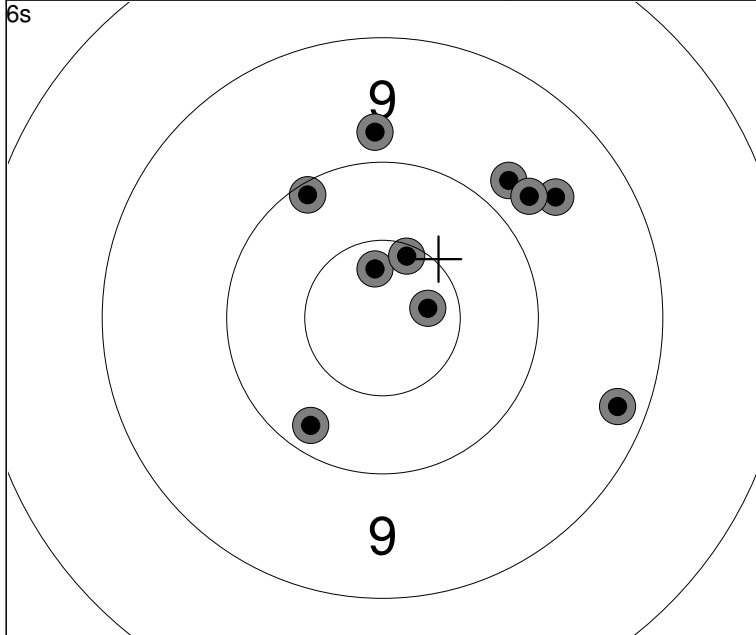

1: 2.34s 10.7x →
2: 3.11s 9.3 ↘
3: 3.74s 10.6x ↑
4: 4.34s 9.6 ↗
5: 5.08s 9.8 ↗

1: 2.29s 10.5x ↑
2: 3.02s 10.1 ↗
3: 3.67s 10.2 ↓
4: 4.29s 9.8 ↑
5: 5.17s 9.7 ↗

Series	95 (3x)
	186 (4x)

1: 1.81s 9.2 ↘
2: 2.43s 7.7 ←
3: 3.00s 9.7 →
4: 3.52s 8.5 ↓
5: 3.93s 9.4 ←

1: 1.67s 8.9 ↘
2: 2.18s 10.3 ↑
3: 2.64s 10.1 →
4: 3.10s 8.7 ↗
5: 3.62s 10.2 ↗

Series	88 (0x)
	274 (4x)

Relay 2	Lane 23	PADDA Davinderjit (dave)		
-------------------	-------------------	---------------------------------	--	--

2023 SFC Pistol Nationals	BC	EX	MP
---------------------------	----	----	----

14.07.2023	23PNRF2S2	Alberta Handgun Association
------------	-----------	-----------------------------

Comment	Signature
---------	-----------

8s 	1:	2.37s	9.9	↘
	2:	3.43s	8.7	←
	3:	4.53s	8.8	↑
	4:	5.48s	7.3	←
	5:	6.56s	10.2	↘
	1:	2.38s	10.1	←
	2:	3.89s	8.4	←
	3:	5.02s	9.8	↑
	4:	6.10s	10.3	←
	5:	7.19s	8.1	←
Series			87 (0x)	
			87 (0x)	

6s 	1:	2.13s	9.3	↖
	2:	3.12s	7.8	←
	3:	4.00s	7.6	←
	4:	4.88s	9.8	↗
	5:	5.81s	9.2	←
	1:	2.31s	9.4	↘
	2:	3.30s	6.8	←
	3:	4.19s	9.2	↘
	4:	5.06s	9.5	←
	5:	6.16s	9.7	↘
Series			83 (0x)	
			170 (0x)	

4s 	1:	1.60s	0.0	↗
	2:	2.57s	8.1	↗
	3:	3.21s	10.8x	→
	4:	3.86s	7.5	↑
	5:	0.28s	↖ ↘	
	1:	1.79s	6.9	↗
	2:	2.42s	9.9	↗
	3:	3.11s	8.2	↘
	4:	3.69s	8.3	↘
	5:	0.11s	↖ ↘	
Series			56 (1x)	
			226 (1x)	

Relay 3	Lane 3	<h1>AASA Toomas</h1>
-------------------	------------------	----------------------

2023 SFC Pistol Nationals	ON	MA	MP
---------------------------	----	----	----

14.07.2023	23PNRF2S2	Alberta Handgun Association
------------	-----------	-----------------------------

Comment	Signature
---------	-----------

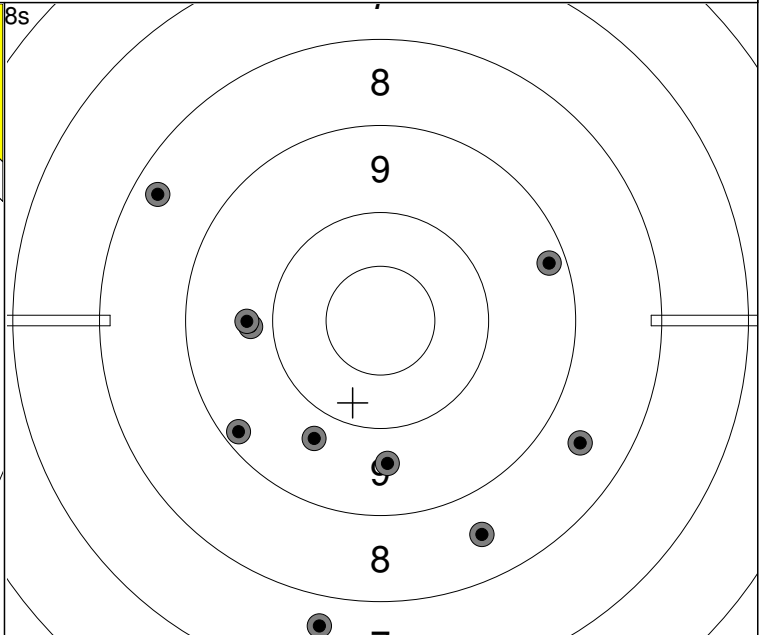
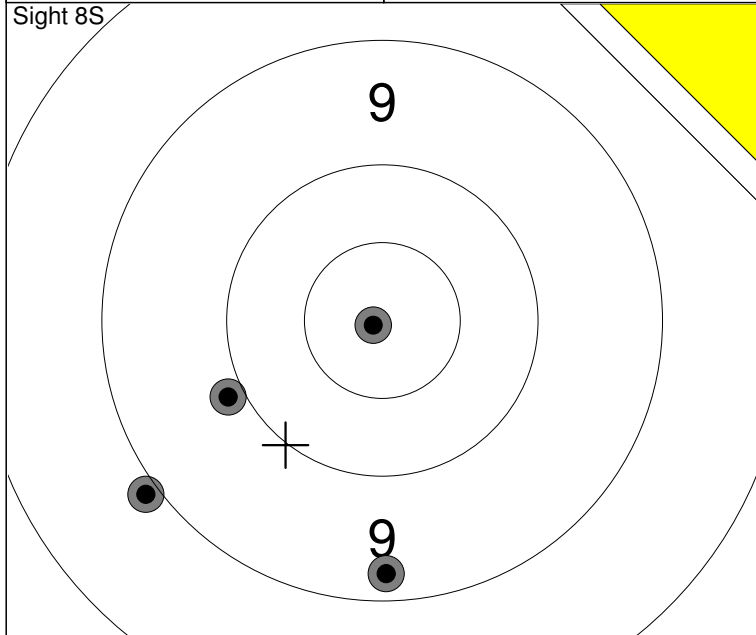

2: 3.37s 9.9 ↙
3: 4.25s 8.9 ↙
4: 5.24s 10.9x ↙
5: 6.80s 9.2 ↓
1: --

Series	36 (1x)
Series	0 (0x)

1: 2.19s 8.5 ↓
2: 3.47s 9.6 ↓
3: 4.55s 9.2 ↙
4: 5.62s 7.7 ↓
5: 6.66s 9.2 →

1: 1.90s 9.8 ←
2: 2.95s 8.6 ↘
3: 3.90s 8.3 ↗
4: 5.00s 9.7 ←
5: 5.96s 9.7 ↘

Series	85 (0x)
Series	85 (0x)

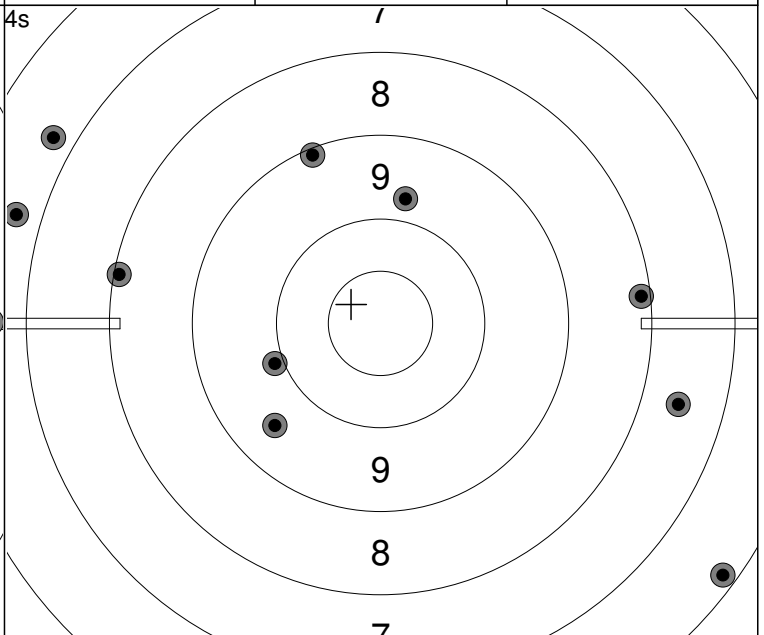
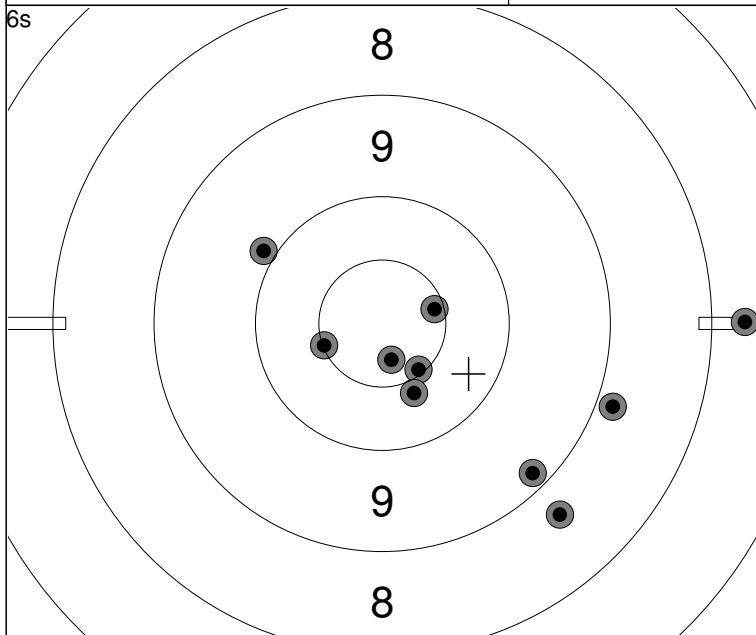

1: 2.10s 9.2 ↘
2: 3.01s 10.7x ↘
3: 4.00s 7.7 →
4: 4.84s 10.5x ↘
5: 5.80s 10.4 ↘

1: 2.02s 10.5x →
2: 2.96s 9.9 ↗
3: 3.72s 8.7 ↘
4: 4.73s 10.5x ←
5: 5.66s 8.9 →

Series	91 (4x)
Series	176 (4x)

1: 1.50s 7.6 →
2: 2.15s 6.8 ↙
3: 2.78s 9.1 ↗
4: 3.32s 8.1 →
5: 3.83s 9.5 ↘

1: 1.54s 9.9 ←
2: 2.18s 6.2 ↘
3: 2.74s 6.7 ←
4: 3.26s 9.7 ↗
5: 3.79s 8.1 ←

Series	77 (0x)
Series	253 (4x)

Relay 3	Lane 8	<h1>MARKEWICZ Alan</h1>
-------------------	------------------	-------------------------

2023 SFC Pistol Nationals	AB	EX	MP
---------------------------	----	----	----

14.07.2023	23PNRF2S2	Alberta Handgun Association
------------	-----------	-----------------------------

Comment	Signature
---------	-----------

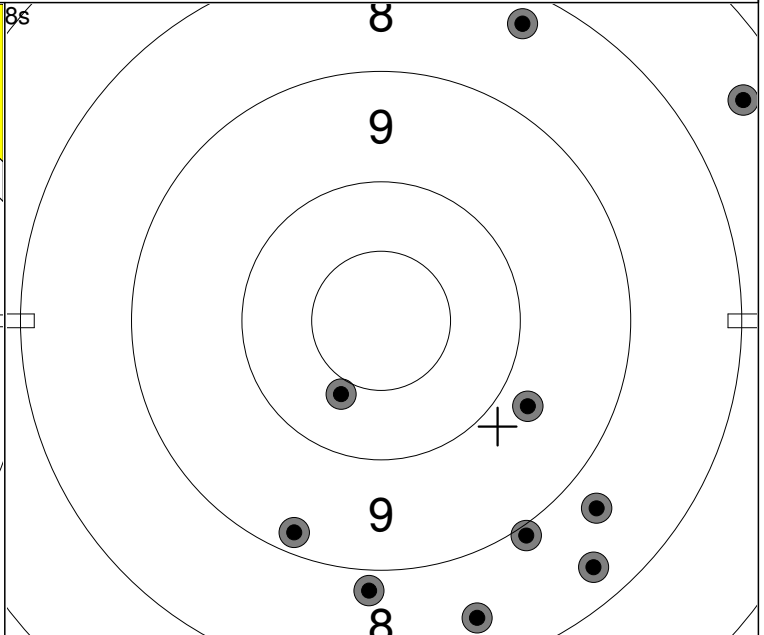
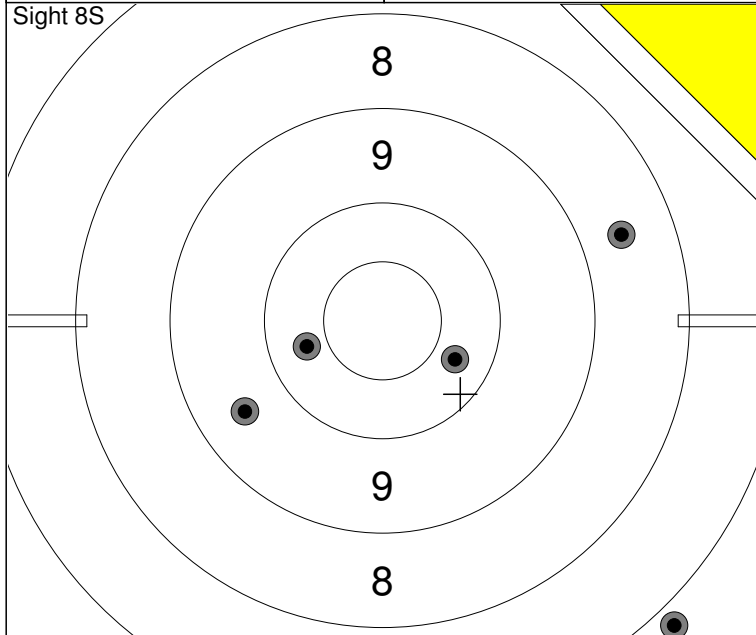

1: 2.64s 10.3 ←
2: 3.73s 9.5 ↙
3: 4.98s 6.8 ↘
4: 6.25s 8.6 →
5: 7.52s 10.3 ↘

Series	43 (0x)
	0 (0x)

1: 2.93s 7.4 ↗
2: 4.04s 8.9 ↘
3: 5.08s 8.8 ↓
4: 6.11s 8.3 ↘
5: 7.27s 10.4 ↘

1: 2.61s 8.3 ↗
2: 3.70s 9.7 ↘
3: 4.80s 8.5 ↘
4: 5.72s 8.7 ↘
5: 6.90s 9.2 ↘

Series	83 (0x)
	83 (0x)

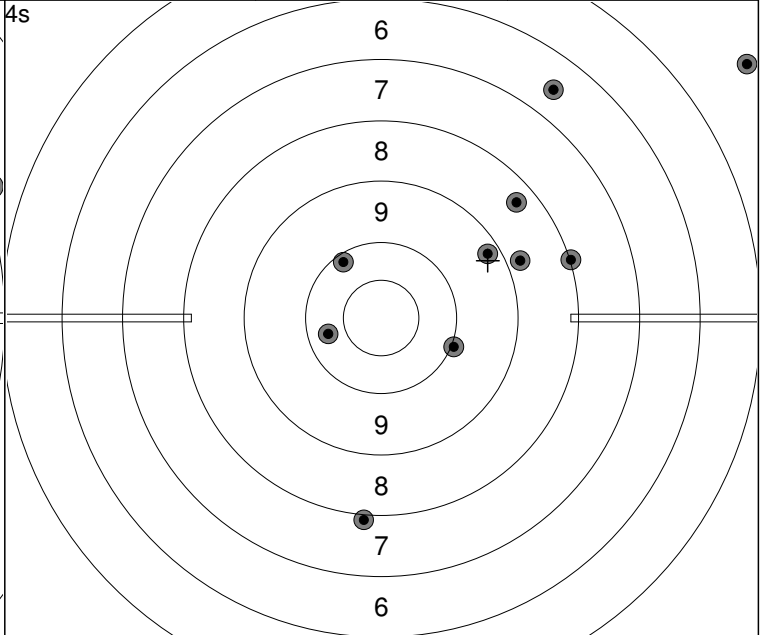
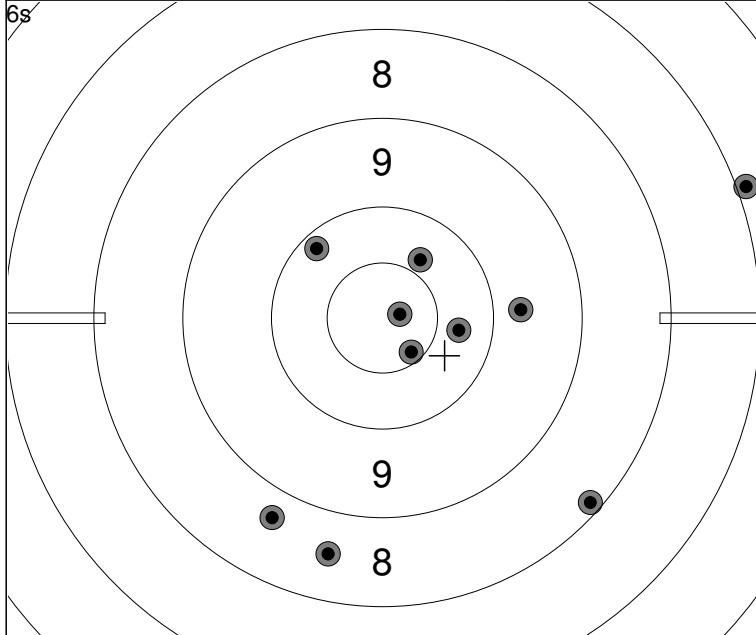

1: 2.20s 10.8x →
2: 3.02s 8.7 ↘
3: 3.82s 10.4 ↗
4: 4.63s 10.6x ↘
5: 5.33s 8.5 ↓

1: 2.17s 9.7 →
2: 2.91s 10.1 ↗
3: 3.74s 6.9 →
4: 4.59s 10.3 →
5: 5.41s 8.1 ↘

Series	89 (2x)
	172 (2x)

1: 1.75s 8.0 →
2: 2.42s 10.3 ←
3: 2.95s 0.0 →
4: 3.46s 7.9 ↓
5: 3.95s 8.3 ↗

1: 1.79s 9.2 ↗
2: 2.33s 10.1 ↗
3: 2.88s 10.0 →
4: 3.36s 6.6 ↗
5: 3.80s 8.8 →

Series	76 (0x)
	248 (2x)

Relay 3	Lane 13	OLSEN Jesse
-------------------	-------------------	--------------------

2023 SFC Pistol Nationals	SK	EX	MP
---------------------------	----	----	----

14.07.2023	23PNRF2S2	Alberta Handgun Association
------------	-----------	-----------------------------

Comment	Signature
---------	-----------

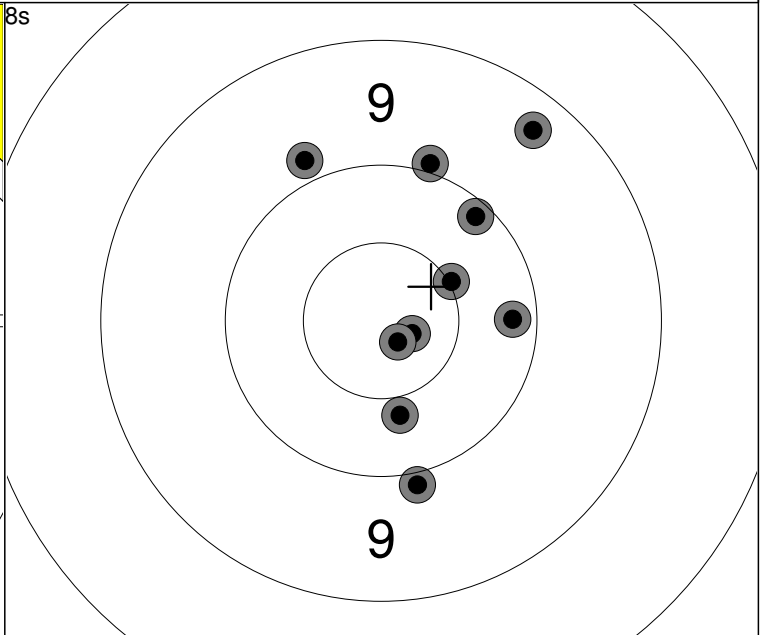
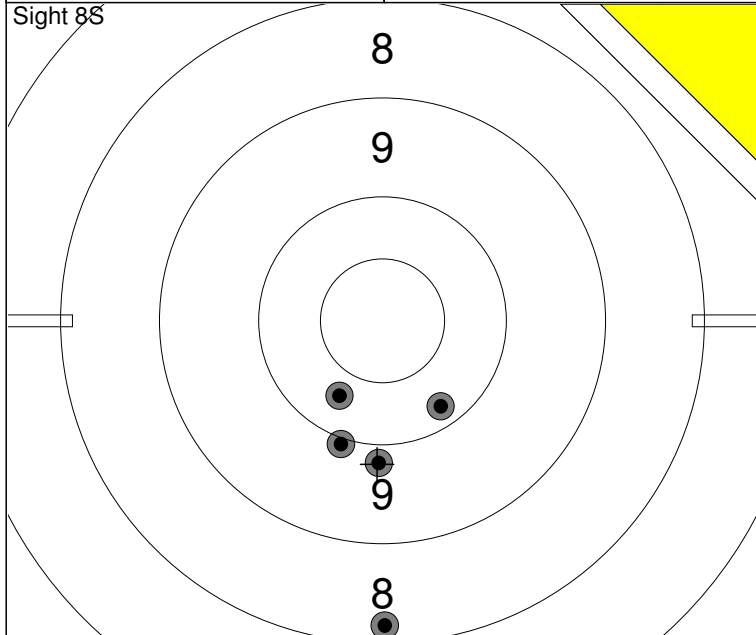

1: 2.28s	8.2	↓
2: 3.31s	10.0	↓
3: 4.20s	10.2	↓
4: 5.26s	9.8	↓
5: 6.49s	10.3	↙

Series	47 (0x)
	0 (0x)

1: 2.14s	10.1	↗
2: 3.38s	9.8	↖
3: 4.56s	9.9	↗
4: 5.61s	9.9	↓
5: 6.70s	10.2	→

1: 2.05s	10.4	↓
2: 3.05s	10.7x	→
3: 4.05s	10.8x	↓
4: 5.07s	10.5x	↗
5: 6.32s	9.3	↗

Series	96 (3x)
	96 (3x)

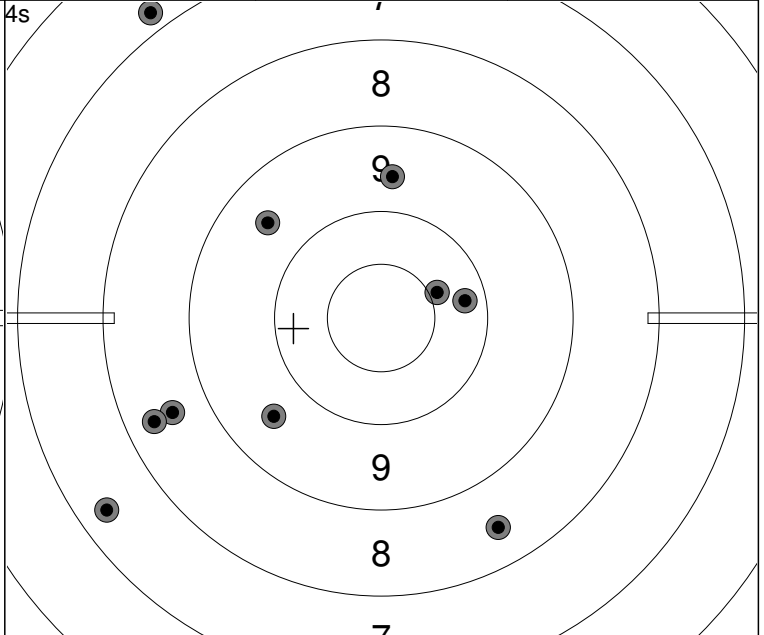
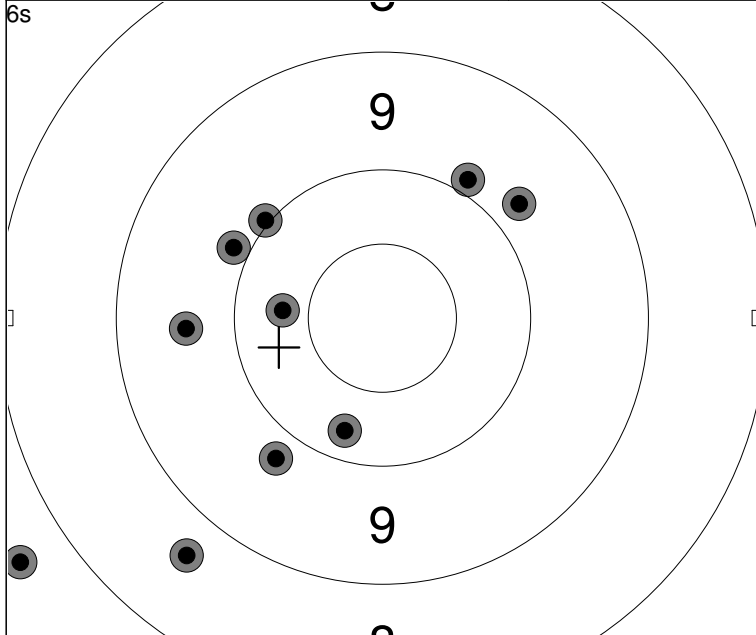

1: 1.81s	9.8	↗
2: 2.56s	7.6	↖
3: 3.40s	10.3	←
4: 4.21s	9.9	↖
5: 5.18s	10.2	↓

1: 2.06s	9.6	←
2: 2.76s	9.8	↓
3: 3.54s	8.7	↓
4: 4.46s	10.0	↖
5: 5.30s	9.9	↗

Series	90 (0x)
	186 (3x)

1: 1.49s	6.8	↖
2: 2.10s	10.2	→
3: 2.64s	9.6	↖
4: 3.09s	9.6	↑
5: 3.59s	9.5	↖

1: 1.56s	8.6	←
2: 2.22s	7.4	↖
3: 2.71s	8.5	↓
4: 3.28s	10.4	↗
5: 3.88s	8.4	←

Series	84 (0x)
	270 (3x)

Relay 3	Lane 18	WICK Werner
-------------------	-------------------	--------------------

2023 SFC Pistol Nationals	AB	MA	MP
---------------------------	----	----	----

14.07.2023	23PNRF2S2	Alberta Handgun Association
------------	-----------	-----------------------------

Comment	Signature
---------	-----------

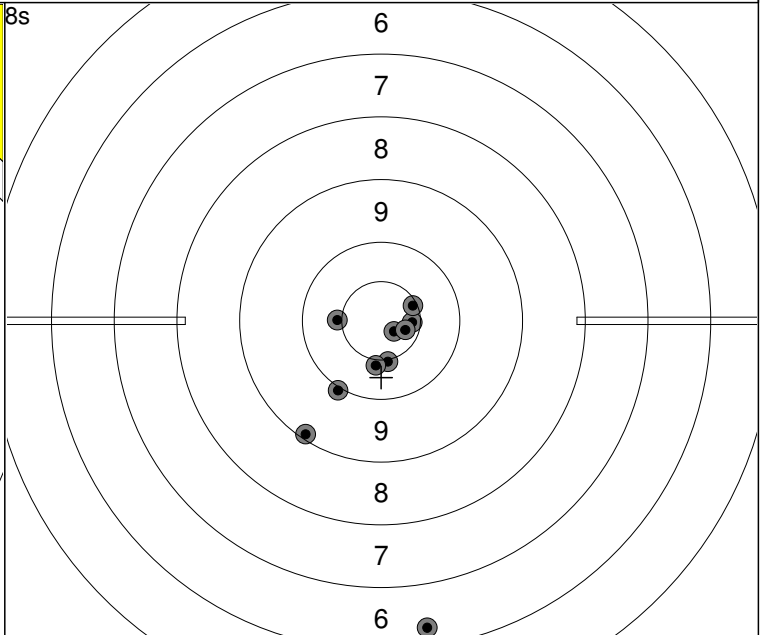
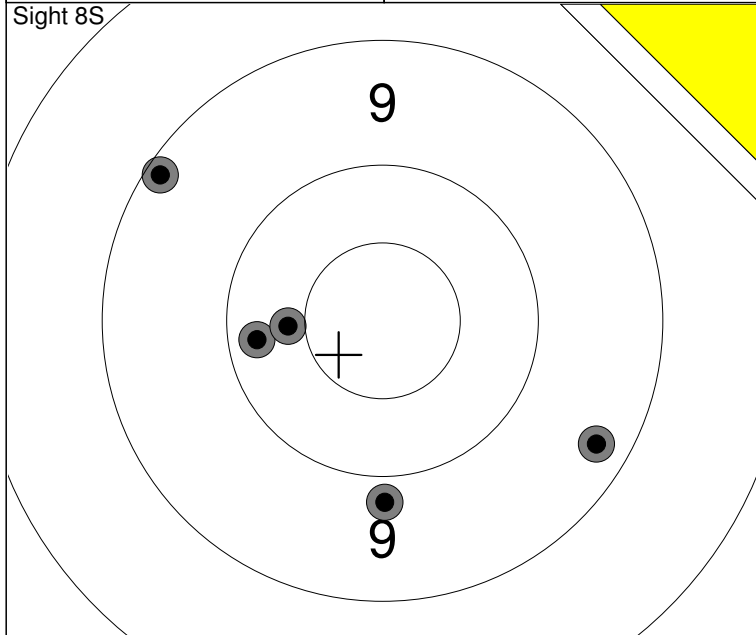

1: 1.98s 9.1 ↖
2: 3.09s 10.2 ←
3: 4.17s 10.4 ←
4: 5.24s 9.8 ↓
5: 6.26s 9.3 ↘

Series	47 (0x)
Series	0 (0x)

1: 2.31s 10.0 ↙
2: 3.25s 10.5x ↓
3: 4.37s 6.3 ↓
4: 5.32s 10.6x →
5: 6.18s 10.4 ↓

1: 1.93s 10.4x ←
2: 3.07s 10.7x ↘
3: 4.11s 10.5x →
4: 5.12s 9.1 ↙
5: 6.06s 10.6x ↘

Series	95 (6x)
Series	95 (6x)

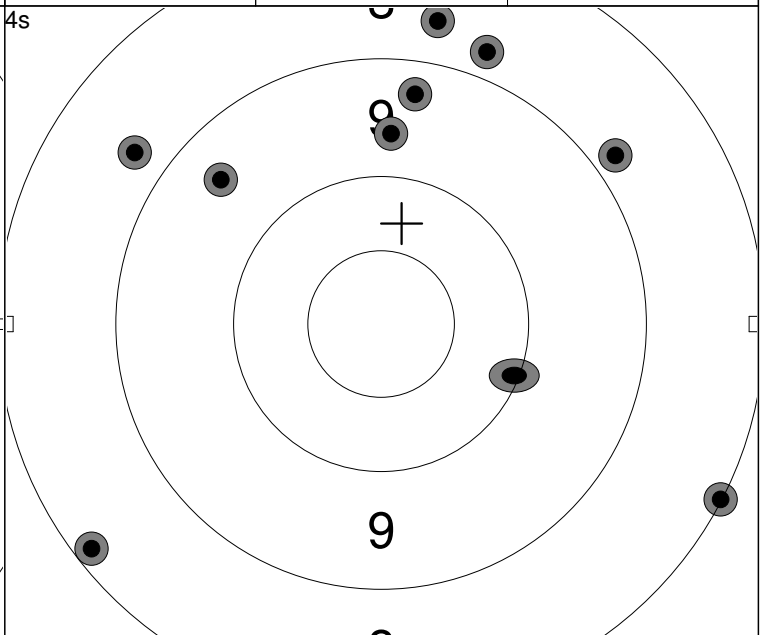
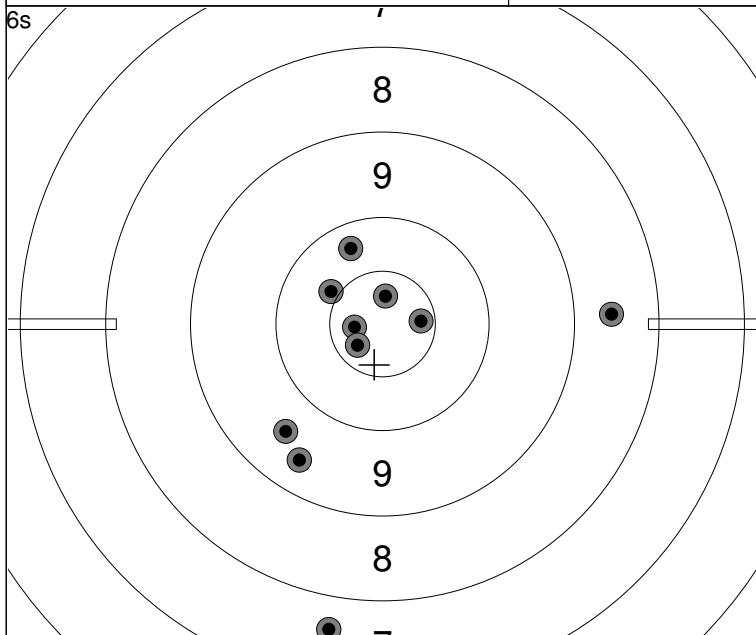

1: 2.18s 9.4 ↙
2: 3.35s 10.7x ←
3: 4.19s 10.4 ↖
4: 5.01s 9.6 ↙
5: 5.79s 10.6x →

1: 1.89s 7.6 ↓
2: 2.85s 10.2 ↗
3: 3.68s 10.7x ↖
4: 4.43s 10.7x ↗
5: 5.09s 8.6 →

Series	93 (4x)
Series	188 (10x)

1: 1.77s 8.8 ↗
2: 2.62s 8.7 ↖
3: 3.38s 9.4 ↖
4: 4.04s 9.7 ↗
5: 0.40s ↘

1: 1.63s 8.0 ↘
2: 2.24s 8.7 ↗
3: 2.75s 9.3 ↗
4: 3.26s 8.2 ↖
5: 3.73s 8.8 ↗

Series	75 (0x)
Series	263 (10x)

Relay 3	Lane 23	PYLE Thomas
-------------------	-------------------	--------------------

2023 SFC Pistol Nationals BC	MA	MP
------------------------------	----	----

14.07.2023	23PNRF2S2	Alberta Handgun Association
------------	-----------	-----------------------------

Comment	Signature
---------	-----------

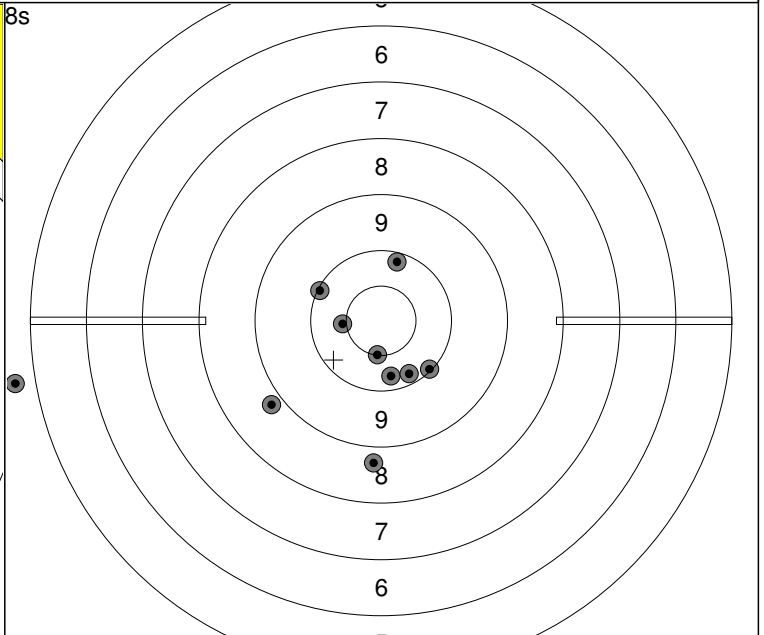
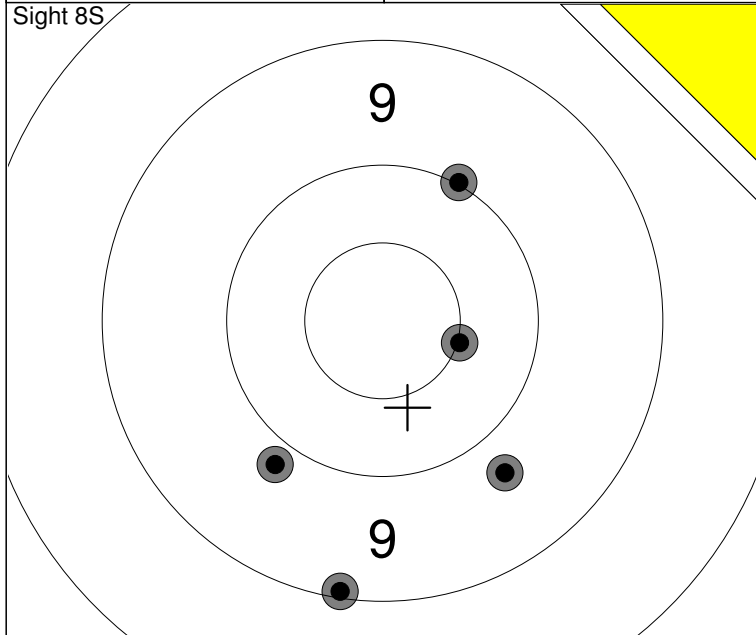

1: 1.94s 10.0 ↗
2: 2.98s 10.5x →
3: 3.93s 9.1 ↓
4: 4.85s 9.8 ↘
5: 5.95s 9.7 ↘

Series	47 (1x)
Series	0 (0x)

1: 1.87s 8.7 ↓
2: 2.81s 10.5x ↓
3: 3.81s 10.2 ↓
4: 4.86s 10.0 ↖
5: 6.10s 8.8 ↙

1: 2.07s 10.1 ↗
2: 3.03s 10.1 ↘
3: 4.12s 10.4x ←
4: 5.00s 0.0 ←
5: 6.06s 10.0 ↘

Series	86 (2x)
Series	86 (2x)

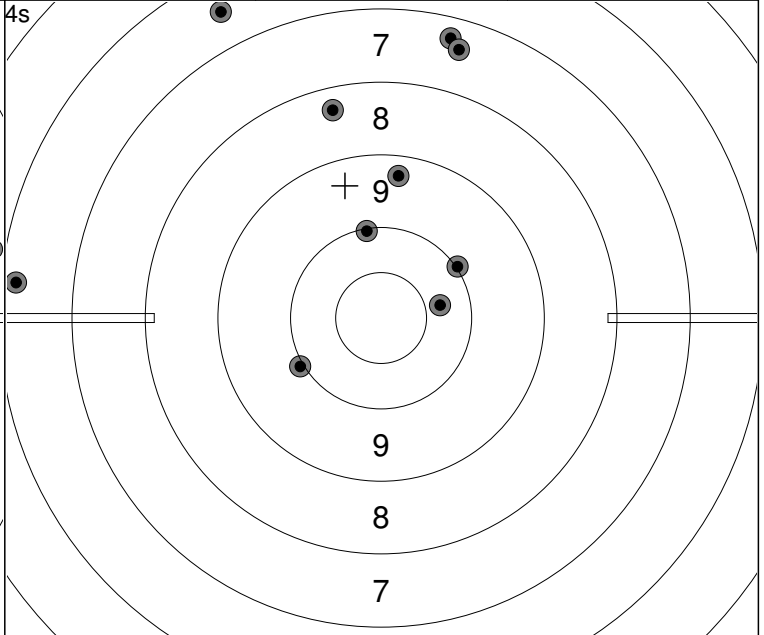
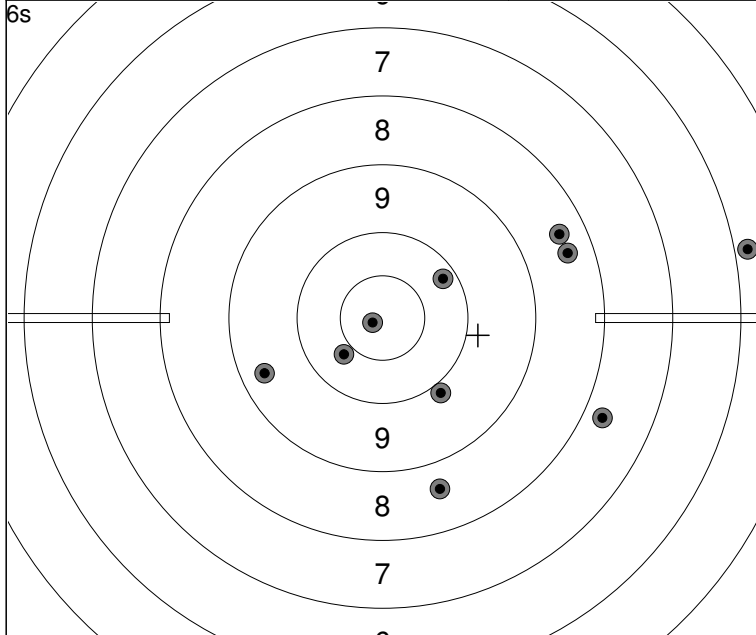

1: 2.01s 10.4 ↙
2: 2.87s 9.9 ↘
3: 3.66s 9.4 ←
4: 4.63s 10.1 ↗
5: 5.43s 5.8 →

1: 1.92s 7.7 →
2: 2.91s 8.4 →
3: 3.80s 8.6 ↓
4: 4.68s 8.4 →
5: 5.62s 10.8x ←

Series	84 (1x)
Series	170 (3x)

1: 1.53s 10.3 →
2: 2.00s 10.0 ↗
3: 2.48s 8.3 ↑
4: 2.91s 6.5 ↖
5: 3.38s 6.2 ←

1: 1.61s 7.3 ↗
2: 2.07s 10.0 ↑
3: 2.57s 9.3 ↑
4: 3.20s 7.4 ↑
5: 3.71s 10.0 ←

Series	83 (0x)
Series	253 (3x)